

## RES-5008

### User Guide



### Important features

- Separate terminal for operation and display
- Automatic zeroing (AUTOCAL)
- Automatic optimisation (AUTOTUNE)
- Automatic configuration of the secondary voltage and current range (AUTORANGE)
- Automatic phase correction (AUTOCOMP)
- Automatic frequency adaptation
- Booster output standard
- Analogue output 0...10 VDC for ACTUAL temperature
- 24 VDC control signals for START and PREHEAT with electrical isolation
- Alarm function with error diagnosis
- Heating element alloy and temperature range can be selected
- Wide voltage range for the use of 110...480 V
- Micro-USB interface for ROPEXvisual®

## Table of contents

<b>1</b>	<b>Revision List</b>	<b>4</b>	<b>8</b>	<b>Commissioning and operation</b>	<b>21</b>
<b>2</b>	<b>General information</b>	<b>4</b>		8.1 Device view	21
	2.1 Use of the operating instructions	4		8.2 Device configuration	21
	2.2 Drawings and illustrations	4		8.3 Burning in and changing the heating element	23
	2.3 Copyright	4		8.4 Commissioning rules	25
<b>3</b>	<b>Safety</b>	<b>5</b>	<b>9</b>	<b>Device functions</b>	<b>27</b>
	3.1 Warning notices in the operating instructions	5		9.1 Display elements and operating elements	27
	3.2 General safety information	6		9.2 Display image of the T-408-1 terminal	28
	3.3 Intended Use	6		9.3 Menu navigation	29
	3.4 User qualifications	7		9.4 Menu structure	30
	3.5 DECLARATION OF CONFORMITY	8		9.5 Menu items	31
<b>4</b>	<b>Requirements for the functioning of the control system</b>	<b>9</b>		9.6 Temperature setting (setpoint specification)	32
	4.1 Heating element	9		9.7 Temperature display/Actual value output	32
	4.2 Impulse transformer	10		9.8 Automatic zero calibration (AUTOCAL)	34
	4.3 Current transformer	10		9.9 Heating up to the sealing temperature (HEAT)	35
	4.4 Line filter	10		9.10 Preheating (PREHEAT-Signal)	36
	4.5 Application report	10		9.11 Hold mode	38
<b>5</b>	<b>Product description</b>	<b>11</b>		9.12 Temperature unit Celsius/Fahrenheit	39
	5.1 Use	11		9.13 Measurement impulse duration	42
	5.2 Functional principle	12		9.14 Automatic phase correction (AUTOCOMP)	42
	5.3 Regulator features	12		9.15 Temperature diagnosis	44
<b>6</b>	<b>Transport and Storage</b>	<b>13</b>		9.16 Heat-up time monitoring	45
	6.1 Scope of Delivery	13		9.17 Restart delay after Reset	45
	6.2 Transport and Storage	13		9.18 Maximum measurement pause	46
<b>7</b>	<b>Mounting and Installation</b>	<b>13</b>		9.19 Communication failure between controller and terminal	46
	7.1 Installation sequence	13		9.20 Undervoltage detection	46
	7.2 Installation notes	15		9.21 Booster connection	47
	7.3 Mains connection	16		9.22 USB-interface for visualisation software ROPEXvisual®	47
	7.4 Line filter	17		9.23 AUX interface	48
	7.5 Current transformer	17		9.24 System monitoring/alarm output	48
	7.6 Circuit diagram (standard)	19		9.25 Error messages	50
	7.7 Circuit diagram with booster connection	20		9.26 Error areas and causes	55
				9.27 Measures in the event of an error	56

---

<b>10</b>	<b>Factory settings</b>	<b>57</b>
<b>11</b>	<b>Maintenance</b>	<b>58</b>
<b>12</b>	<b>Disposal</b>	<b>58</b>
<b>13</b>	<b>Technical data</b>	<b>59</b>
<b>14</b>	<b>Dimensions</b>	<b>61</b>
<b>15</b>	<b>Modifications (MODs)</b>	<b>62</b>
<b>16</b>	<b>How to order</b>	<b>63</b>
<b>17</b>	<b>Index</b>	<b>65</b>

# 1 Revision List

Version	Modification
1	<ul style="list-style-type: none"><li>• Preparation of documentation</li></ul>
2	<ul style="list-style-type: none"><li>• New: section 9.12.1 "TCR Calculator" on page 40</li><li>• New: section 9.17 "Restart delay after Reset" on page 45</li><li>• New: section 9.18 "Maximum measurement pause" on page 46</li></ul>
3	<ul style="list-style-type: none"><li>• Addition: list „The AUTOCAL function is blocked.“ ↳ section 9.8 "Automatic zero calibration (AUTOCAL)" on page 34</li><li>• Distinction: supply inrush current and control mode ↳ section 13 "Technical data" on page 59</li></ul>

## 2 General information

This RESISTRON<sup>®</sup> Temperature Controller has been developed and manufactured as per EN 61010-1 and is checked and monitored several times during manufacture as part of quality assurance. The device is leaving our factory in perfect condition.

### 2.1 Use of the operating instructions

These operating instructions are part of the product and describe the installation, start-up, operation, troubleshooting and maintenance of the RESISTRON<sup>®</sup> Temperature Controller.

Please read the operating instructions carefully before using the RESISTRON<sup>®</sup> Temperature Controller. Keep the operating instructions safe, for future reference. Please ensure that the important information and the functions are always available to the user in the vicinity of the RESISTRON<sup>®</sup> Temperature Controller.

In order to ensure safe operation, please observe the safety and warning information included in the operating instructions.

### 2.2 Drawings and illustrations

The drawings and illustrations in these operating instructions are exemplary. Many details are presented in a simplified manner.

### 2.3 Copyright

All contents, in particular texts, photographs and graphics, are protected by copyright. All rights, including to replication, publication, editing and translation, are reserved.





## 3 Safety

### 3.1 Warning notices in the operating instructions

These operating instructions contain warning notices if there is a risk of personal injury or property damage. The signal words in the warning notices draw attention to the particular dangers and indicate the severity of the danger. The warning notices contained in the operating instructions must be observed in order to ensure safe operation.

#### 3.1.1 Meaning of the signal words

The following signal words indicate the risk of personal injury and property damage:

Signal word	Importance
	Imminent danger Consequence: Death or serious injuries
	Possibly imminent danger Consequence: Death or serious injuries
	Possibly imminent danger Consequence: Slight or minor injuries
	Possibly imminent danger Consequence: Damage to property or environment

#### 3.1.2 Structure of section-related warnings

Section-related warnings apply to a section, a course of action or a specific procedure. They don't just apply to a specific act. The hazard symbols used indicate a general or specific hazard.

Section-related warnings are structured as follows:

Hazard symbol	SIGNAL WORD
	Type of danger and possible consequences Measures to avert the danger

#### 3.1.3 Structure of embedded warnings

Embedded warnings refer to a specific part within a paragraph. These warning notices apply to information units smaller than the section-related warning notices.

Embedded warnings are structured as follows:



#### SIGNAL WORD

Instructions to avoid a dangerous situation

### 3.1.4 Meaning of the hazard symbols

The hazard symbols in the warning notices have the following meanings:



Warning of a danger point or dangerous situation



Warning of electrical voltage



### 3.1.5 Information code

The following symbol indicates important information:



important information on the correct handling of the product

## 3.2 General safety information

	<p><b>⚠ WARNING</b></p> <p>Danger to life and danger of serious physical injuries as well as property damage if all warnings, regulations and information are not followed.</p> <p>Strictly follow all warnings, regulations and information in these operating instructions!</p>
	<p><b>⚠ WARNING</b></p> <p>Danger to life and risk of serious physical injuries as well as property damage if the work is not carried out in a professional and professional manner.</p> <p>Installation, electrical connection, start-up and maintenance of the RESISTRON<sup>®</sup> Temperature Controller may be carried out only by qualified, trained personnel in accordance with these operating instructions. Unauthorized and improperly carried out work during installation and reconstruction, electrical connection, start-up and maintenance is prohibited for safety reasons!</p>

## 3.3 Intended Use

RESISTRON<sup>®</sup> Temperature Controllers may be used only for heating and temperature control of heating elements that are expressly suitable for this purpose, in compliance with the regulations, notes and warnings listed in these instructions.

	<p><b>NOTE</b></p> <p>In case of non-compliance or improper use, there is a risk of impairment of safety or overheating of heating elements, electrical lines, transformers, etc. This is the user's own responsibility.</p>
---	--

### **3.4 User qualifications**

Only qualified specialists are allowed to carry out work such as assembly, installation, start-up and operation as well as troubleshooting and maintenance of the RESISTRON<sup>®</sup> Temperature Controller. Qualified specialists are persons who have been instructed in electrical engineering and who have the minimum qualifications required for their work. These persons are familiar with the dangers and the guarantee provisions and they have read and understood the operating instructions.

### 3.5 DECLARATION OF CONFORMITY

We hereby declare that the following device has been developed and manufactured in conformance with the directives cited below:

Designation: RESISTRON/CIRUS temperature controller with accessories  
Type: With line filter and current transformer  
Operating principle: Impulse sealing of films and plastics

#### Compliant with following standards and directives:

EN 61010-1 Safety requirements for electrical equipment, control, and laboratory use  
2014/35/EU Low voltage directive  
2014/30/EU Electromagnetic compatibility directive  
2011/65/EU RoHS directive

#### Note:

This declaration of conformity certifies that the device/electronic itself complies with the above-mentioned directives. The CE mark on the device/electronic does not relieve the machinery manufacturer of his duty to verify the conformity of the completely installed, wired and operationally ready system in the machine with the EMC directive.

#### Comments:

RESISTRON/CIRUS temperature controllers are not independently operable devices. They are used by the machinery manufacturer to form a sealing system by adding EMC-relevant components such as filters, transformers, heatsealing bands and wiring. The final configuration may vary significantly in terms of performance and physical dimensions. All information provided by us in connection with the line filter is merely intended as a guide and is based on a typical measuring setup. It serves to demonstrate that compliance with the EMC directive can be achieved by using a line filter that is suitable for the overall system. The line filter and current transformer must, however, be determined on the basis of the respective application. We also wish to point out that the transformer which is used must be designed in accordance with VDE 0551/EN 61558 or UL 5058 for safety reasons.

July 12, 2020

  
\_\_\_\_\_  
J. Kühner (CEO)

ROPEX Industrie-Elektronik GmbH  
Adolf-Heim-Str. 4  
74321 Bietigheim-Bissingen (Germany)



## 4 Requirements for the functioning of the control system

### 4.1 Heating element

The resistance of the heating element used must have a positive temperature coefficient for the proper functioning of the RESISTRON® Temperature Controller.

In order to achieve an optimal sealing result, the heating element and the type of connection must be adapted to the sealing application. The geometry of the heating element cannot be discussed here due to its diversity.

Accordingly, only some important physical and electrical characteristics are pointed out here:

The measurement principle used here requires a suitable temperature coefficient TCR from the heating element alloy. The RESISTRON® Temperature Controller is suitable for temperature coefficients in the range 400...4000 ppm/K.

As the heating element heats up, the resistance value increases, through which the control is made possible. If the temperature coefficient of the heating element is below the range, the control circuit oscillates or the heating element overheats.

	NOTE
<p>If the temperature coefficient of the heating element is greater than the set value, the real temperature is lower than the displayed temperature. However, if the temperature coefficient of the heating element is greater than the set value, the real temperature is higher than the displayed temperature.</p>	

The temperature coefficient must be given as follows:

$$TCR = 10 \times 10^{-4} K^{-1} \text{ or } K^{-1} \text{ or ppm/K}$$

E.g. Alloy A20: TCR = 1100 ppm/K  
 Alloy L: TCR = 780 ppm/K  
 LEX3500: TCR = 3500 ppm/K  
 Vacodil: TCR = 1100 ppm/K

The setting or coding of the RESISTRON® Temperature Controller has to be carried out according to the temperature coefficient of the heating element used.

The temperature coefficient must be taken from the ROPEX application report and must be set accordingly.

	⚠ WARNING
<p>The use of the wrong alloys with a temperature coefficient, which is too low, or the wrong coding of the RESISTRON® Temperature Controller leads to uncontrolled heating and possibly to the burning up of the heating element!</p>	

More information:

- High-resistance heating elements, such as NiCr 80/20, are not suitable for an operation with a RESISTRON® Temperature Controller.
- **Parallel wiring:** In order to achieve an uniform temperature of both the heating elements, symmetrical cabling must be taken into account in case of parallel wiring of heating elements.
- **Series wiring:** When heating elements are connected in series, it must be ensured that the heating elements do not touch each other when they are heated on both sides. This would lead to an overcurrent and consequently to a selective increase in temperature.

- A very important design measure is copper-coating or silver-coating of the heating element ends. The thermal characteristics change in this range through coating of the heating element ends. As a result, the ends remain cold, which permits exact temperature control and increases the useful life of the heating element and the wear materials (e.g. silicone underlayment, heating band cover).

## 4.2 Impulse transformer

A suitable impulse transformer is required for the control loop to function properly. The power and the secondary voltage must be laid out for the control loop. According to EN 61558 or UL 5058, the transformer must be laid out as an isolating transformer with reinforced insulation and have a single-chamber structure. Adequate protection against accidental contact must be provided when assembling the impulse transformer. The relevant national installation and construction regulations must be observed, while doing so. Water, cleaning solutions and / or conductive liquids may not come into contact with the impulse transformer.

The cable cross-sections must be designed as per the ROPEX application report.

Incorrect assembly and installation of the impulse transformer impair electrical safety.

The terminals on the pulse transformer must be checked and tightened regularly.

## 4.3 Current transformer

The current transformer appropriate for RESISTRON<sup>®</sup> Temperature Controller is part of the control system.

In order to avoid malfunctions, only the original ROPEX current transformers or ROPEX monitoring current transformers may be used.

The current transformer may be operated only if it is correctly connected to the RESISTRON<sup>®</sup> Temperature Controller (See Chapter "Start-up"). The safety-related information in the "Mains connection" chapter must be observed. External monitoring modules can be used to increase operational safety furthermore. Monitoring modules are not part of the standard control system and are described in separate documentation.

## 4.4 Line filter

ROPEX offers line filters in various performance classes. The ROPEX Application Report lists the suitable line filter, which can be ordered.

For fulfilling the guidelines mentioned in the section 1.5 "DECLARATION OF CONFORMITY" on page 6, it has been stipulated to use an original ROPEX line filter. Installation and connection must be carried out in accordance with the instructions in the "Mains connection" chapter or the separate documentation for the respective line filter.

## 4.5 Application report

The ROPEX application report contains all the important technical information on your sealing applications. If you have several applications in a system, these are displayed in the application report on different pages and columns. This allows you to easily differentiate between them. The application report is created individually by the ROPEX application team and is the basis for the electro-technical design of your sealing applications.

The ROPEX application report contains the following information among other things:

- List of the different heating element dimensions
- Specification of the necessary temperature coefficient

- Electro-technical data as the basis for the electrical components
- Parts list and schematic diagram for the necessary components
- Instructions and recommendations for mechanical design
- Instructions for installing the cables and components

To receive a ROPEX application report, please fill out our [questionnaire](#) completely. When you send the completed questionnaire, a new window opens with a reference number (e.g. AR1234) and a link to the questionnaire you created. This link enables you to reopen the questionnaire for your next inquiry. We therefore recommend that you save the link and the reference number.

Subsequently, you will have the opportunity to send us further information on this questionnaire, such as for example, technical descriptions or pictures.

The ROPEX application team then creates the application report based on the data you have entered. If relevant data is missing, we will contact you to clarify the open points. As soon as the application report has been created, you will receive it by email. We will then send you an offer for the components listed in the application report.

If you cannot judge whether your material can be sealed or what cycle rate is possible, we can also create sealing samples for you. We will then use our system and your material to check the possibility for sealing and incorporate the findings into the application report.

In this case you are welcome to contact [info@ropex.de](mailto:info@ropex.de). Your request will then be passed on to the application team to coordinate the next steps.

## 5 Product description

### 5.1 Use

This RESISTRON<sup>®</sup> Temperature Controller is part of the “RES-5000 Series”. All RESISTRON<sup>®</sup> Temperature Controllers are used for regulating the temperature of heating elements. Heating elements are used in a wide variety of foil sealing processes.

The most common heating elements include:

- flat bands (straight and contoured)
- tapered bands
- beaded bands
- cutting wires (straight and contoured)
- heated sealing and cutting knives
- soldering brackets

The main application area is sealing or cutting of thermoplastics using the thermal impulse process.

The most common application areas are:

- vertical and horizontal flow wrapping machines (VFFS and HFFS)
- bagging, filling and sealing machines
- film-wrapping machines
- bag-production machines
- group packaging machines
- film sealing devices
- spout and tube sealing
- and much more.

## 5.2 Functional principle

The resistance of the heating element, which changes with temperature, is measured by means of current and voltage measurement, displayed and compared with the specified setpoint value. Measurements are made 50 times per second in a 50 Hz mains, 60 times per second in a 60 Hz mains.

The primary voltage of the impulse transformer is adjusted following the phase angle control principle, if the measured values deviate from the setpoint value. The related current change in the heating element results in a rise in temperature and change of resistance. This change in resistance measured and evaluated by the RESISTRON<sup>®</sup> Temperature Controller RES-5008. The temperature controller adjusts the control variables according to the change and the adjusted setpoint value.

Even the smallest thermal loads on the heating element are recorded and can be quickly and precisely corrected. The measurement of pure electric variables, together with the high measurement rate, result in a highly dynamic thermoelectric control circuit. The principle of primary-side transformer control proves to be especially advantageous as it permits a very large secondary current range with low power loss. This permits an optimal adjustment to the load and thus the desired dynamics with extremely compact device measurements.

## 5.3 Regulator features

The RESISTRON<sup>®</sup> Temperature Controller RES-5008 is controlled through the separate T-408-1 operator terminal. The T-408-1 operator terminal can be used to adjust functions and parameters and also to display important controller information.

The ACTUAL temperature of the heating element is output through the operator terminal and through an analogue output 0...10 VDC. The real heating element temperature can be visualised on an additional external display instrument.

The RES-5008 has an integrated error diagnosis. The error diagnosis checks the external system (heating element, wiring, etc.) as well as the internal electronics. A differentiated error message is output through the T-408-1 operator terminal, in case of malfunction.

The adjustment for different heating element alloys (alloy A20, Vacodil, etc.) and the adjustment of the temperature range to be used (0...300 °C or 0...500 °C) can be made through coding switches on the RESISTRON<sup>®</sup> Temperature Controller RES-5008 or through the ROPEXvisual<sup>®</sup>.

The compact design of the RESISTRON<sup>®</sup> Temperature Controller RES-5008 as well as the plug-in connecting terminals make mounting and installation easier.

An overview of the most important features and functions:

- AUTOCAL - Easy calibration of the heating element by automatic zeroing.
- AUTOTUNE - high regulation dynamics by automatic adaptation to the regulating line.
- AUTORANGE - automatic configuration of the secondary voltage range and current range, high flexibility due to the coverage of a secondary voltage range from 0.4 V to 120 V and a current range from 30 A to 500 A.
- AUTOCOMP - automatic phase correction
- Automatic adjustment to the mains frequency in the range of 47 Hz to 63 Hz.
- Wide voltage range for flexible use from 110 VAC to 480 VAC
- Easy and convenient system diagnosis and process visualisation through the free, downloadable software ROPEXvisual<sup>®</sup>
- Comprehensive error diagnosis
- Booster output available for connecting a switching amplifier

## 6 Transport and Storage

### 6.1 Scope of Delivery

After taking delivery, check if the delivery is complete immediately, with the help of the accompanying documents. After taking delivery, perform a visual inspection for possible damage.

	<b>NOTE</b>
	ROPEX Industrie-Elektronik GmbH does not assume any guarantee for defects that are subsequently claimed.

### 6.2 Transport and Storage

Transport and store the device in its original box. For the ambient conditions, please refer to the technical data (↪ section 13 "Technical data" on page 59). After a longer period of storage of the RESISTRON® Temperature Controller RES-5008, ROPEX Industrie-Elektronik GmbH will handle the functionality testing for a fee.

## 7 Mounting and Installation

↪ See also section 4 "Requirements for the functioning of the control system" on page 9.

	<b>⚠ WARNING</b>
	The assembly, installation and commissioning may be performed only by technically trained and competent persons. The persons must be familiar with the dangers associated with it and guarantee provisions.

	<b>CAUTION</b>
	The supply voltage to the machine side must lie within the permitted voltage and frequency range of the temperature controller. Otherwise, there is the danger of a defect.

### 7.1 Installation sequence

Proceed as follows during mounting and installation of the RESISTRON® Temperature Controller RES-5008:

1. Switch off mains voltage and 24 VDC power supply; verify lack of voltage.
2. Installation of the RESISTRON® Temperature Controller in the switching cabinet on a TS35 top-hat rail in accordance with EN 60715. If several devices are mounted, the minimum distance specified in section 12 "Disposal" on page 58 must be maintained.
3. Installation of the operator terminal in the panel cut-out. It is fastened with four clips that snap into place laterally at the terminal housing.

4. Wiring of the system in accordance with the regulations in section 7.3 "Mains connection" on page 16, section 7.6 "Circuit diagram (standard)" on page 19 and the ROPEX application report. The specifications in section 7.2 "Installation notes" on page 15 must also be observed.

Cables that are connected to control or measurement connections may only run within the building.

5. During installation, an overcurrent protection device with max. 10 A must be provided, e.g.:
  - circuit breaker in accordance with EN 60898 (characteristic B, C, D, K or Z)
  - circuit breaker in accordance with UL489 (\*) (characteristic B, C, D, K or Z)
  - protective fuse gG in accordance with IEC 60269
  - protective fuse "Class CC" or "Class J" in accordance with UL 248 (\*)

The overcurrent protective devices marked with (\*) must be used in installations falling under the UL regulations.

If the specified overcurrent protection device is not sufficient for the sealing application, two separate overcurrent protective devices must be provided for the regulator and the sealing application (↪ ROPEX application report).

The overcurrent protective device must be located in the immediate vicinity of the device.

In the ROPEX application report, the smallest possible specification for this overcurrent protection device is specified based on the calculated currents. If the protection device is dimensioned differently, the current load capacity of the components used (e.g. cable, impulse transformer, etc.) must be adjusted accordingly.

6. A disconnect device must be provided during installation. The disconnect device must be properly marked as part of the system and attached in an easily accessible position.

If a circuit breaker is used, it can take over the function of the disconnect device.

7. Connection of the RESISTRON<sup>®</sup> Temperature Controller RES-5008 with the operator terminal T-408-1 using the appropriate cable.

**CAUTION**

**Check all connection terminals of the system – including the terminals for the coil wires on the impulse transformer – as to whether they are fixed firmly.**

8. Check the wiring in accordance with the applicable national and international installation and setup requirements.

## 7.2 Installation notes

	<p><b>NOTE</b></p>
<p>The correct dimensioning of the system components is crucial for the correct functioning of the control loop. Please take this data from the ROPEX application report.</p>	

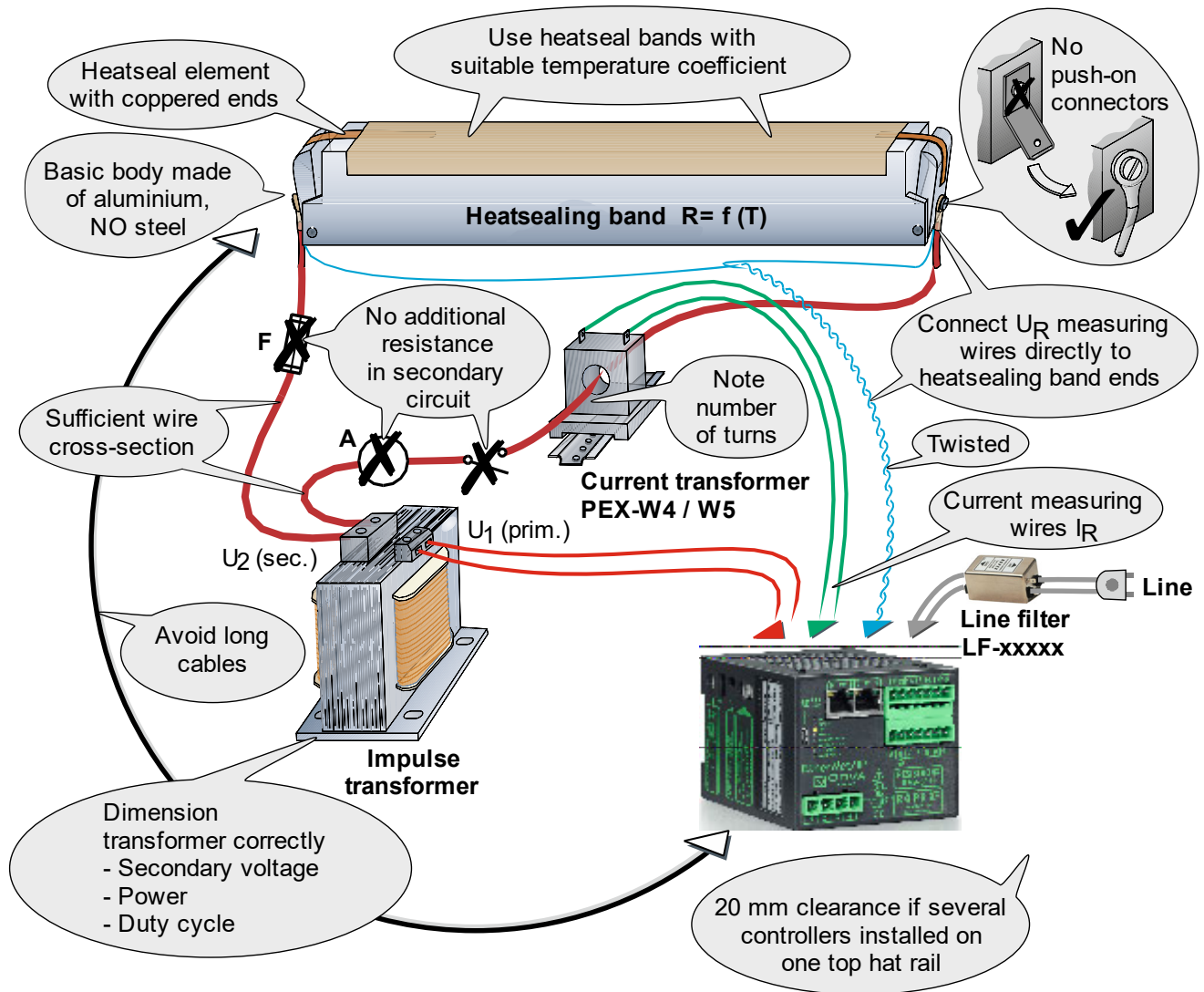

	<p><b>NOTE</b></p>
<p>In order to enable a good and stable regulation, additional resistances (fuses, long lines, plug connections, ...) must be avoided in the secondary circuit.</p> <p>Additional resistances influence the regulation and can make the system prone to errors, in the long term.</p>	

**7.3 Mains connection**

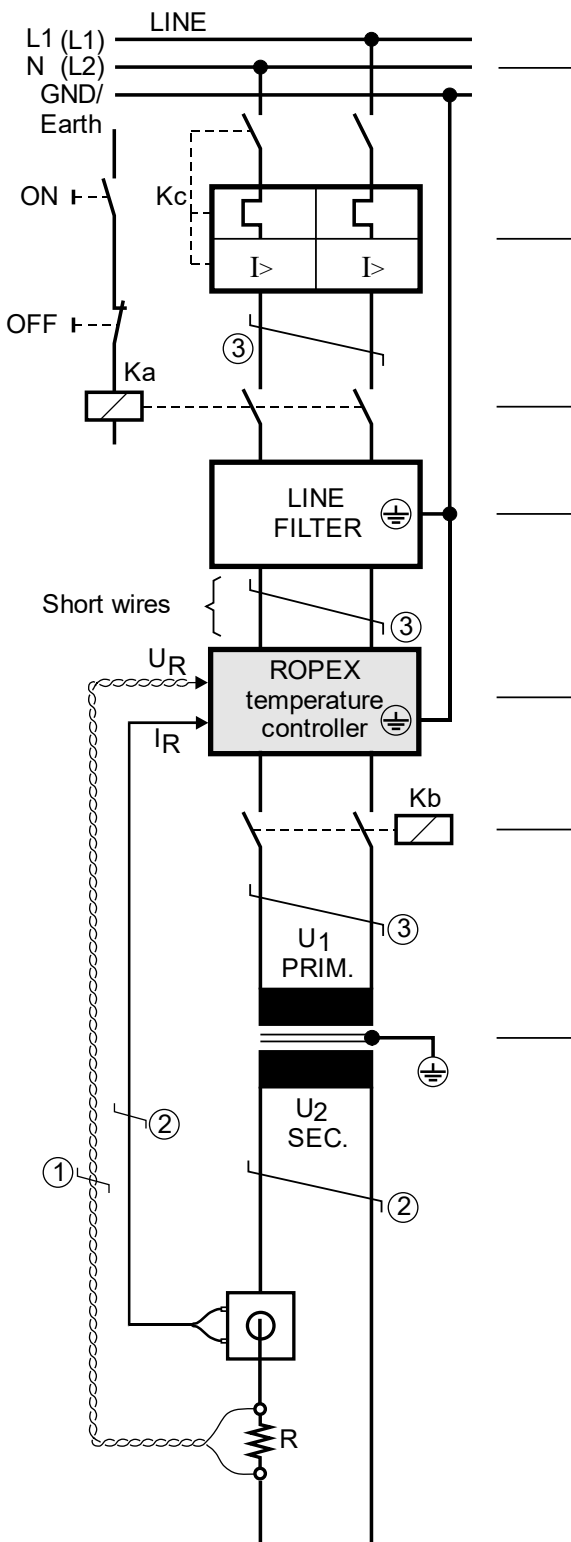

**Line**

To avoid disturbances while measuring, place several control loops on the same phase if possible.

**Overcurrent device**

2-Pole circuit breaker or fuses, (↪ ROPEX application report).



**ATTENTION - protection only in the event of a short circuit.**

**No protection of the RESISTRON® Temperature Controller.**

**Contactor Ka**

For all-pole disconnection, EMERGENCY OFF or EMERGENCY STOP.

Dimensioning ↪ ROPEX application report

**Line filter**

Filter type and filter size must be based on load, transformer and machine cabling (↪ ROPEX application report).



**CAUTION Do not lay filter supply lines (mains side) parallel to filter output lines (load side).**

**RESISTRON® Temperature Controller**

**Contactor Kb**



**CAUTION To increase machine safety by switching off the load on all poles in the event of a fault, e.g. in combination with the ALARM output of the RESISTRON® Temperature Controller.**

Dimensioning ↪ ROPEX application report  $I_{1max}$  (for Ka and Kb)

**Impulsetransformer**

Design according to EN 61558 or UL 5058 (isolating transformer with reinforced insulation). Ground core.



**CAUTION Use only single-chamber design. Power, ED number and voltage values must be determined individually depending on the application (↪ ROPEX application report).**

**Wiring**

Cable cross-sections depend on the application (↪ ROPEX application report).

- ① Make sure to twist (min. 20 beats/meter, ↪ Accessories “twisted measuring line”)
- ② Twisting (min. 20 beats/meter) necessary if several control loops are laid together (“Crosstalk”).
- ③ Twisting (min. 20 beats/meter) recommended to improve EMC properties.



## 7.4 Line filter

In order to comply with the EMC directive, RESISTRON control loops must be operated with earthed line filters. The earthed line filters serve to attenuate the effect of the phase-angle control on the line and to protect the controller against line disturbances.



### CAUTION

The use of a suitable line filter is part of compliance with the standards and a prerequisite for CE marking.

ROPEX line filters are specially optimized for use in RESISTRON control loops and guarantee compliance with the EMC limit values when installed and wired correctly. The specification of the line filter can be found in the ROPEX-application report created for your sealing application.

Further technical information: ↪ Documentation "line filter".

The supply of several control loops via a line filter is permitted if the total current does not exceed the maximum current of the filter.

The instructions in the section 7.3 "Mains connection" on page 16 with regard to cabling must be complied with. Example drawing for LF-06480:

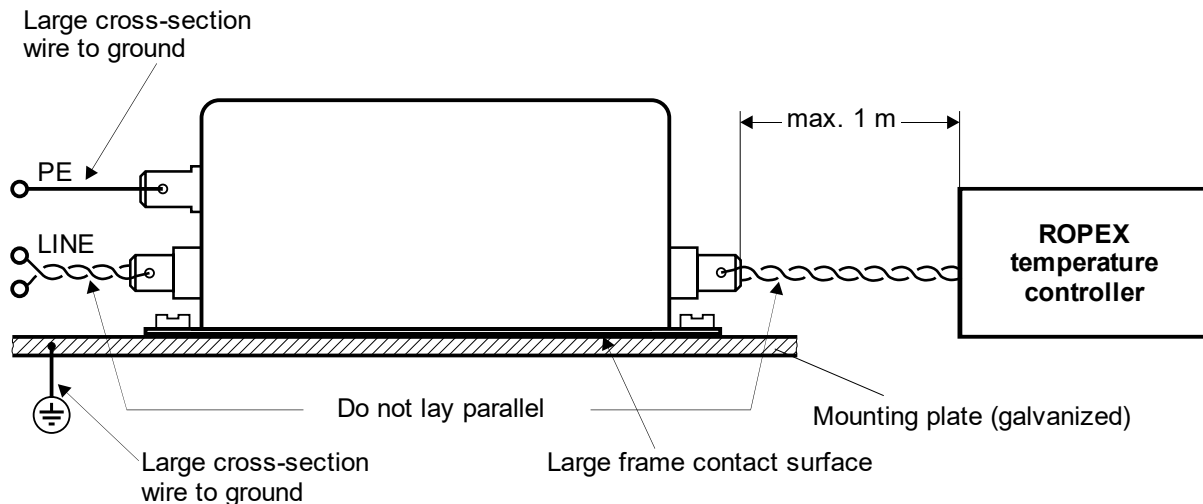

## 7.5 Current transformer

The current transformer PEX-W4/-W5 appropriate for RESISTRON<sup>®</sup> Temperature Controller is part of the control system. The current transformer may be operated only if it is correctly connected to the temperature controller (↪ section 7.3 "Mains connection" on page 16).

If several heating elements are operated with one control circuit, the installation can be found in the ROPEX application report. In special applications with RESISTRON<sup>®</sup> Temperature Controller it is necessary that a short circuit between the heating element and earth/housing is detected and the control system is switched off immediately. The MSW-2 monitoring current transformer can be used for this.

Further technical information can be found in the separate documentation for the current transformer and monitoring current transformer.

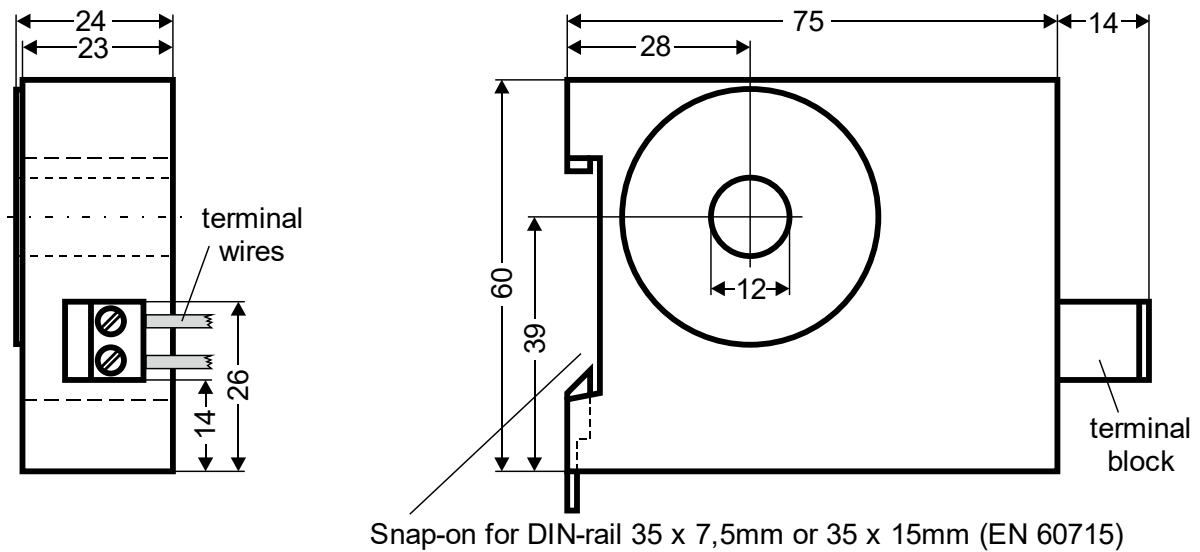
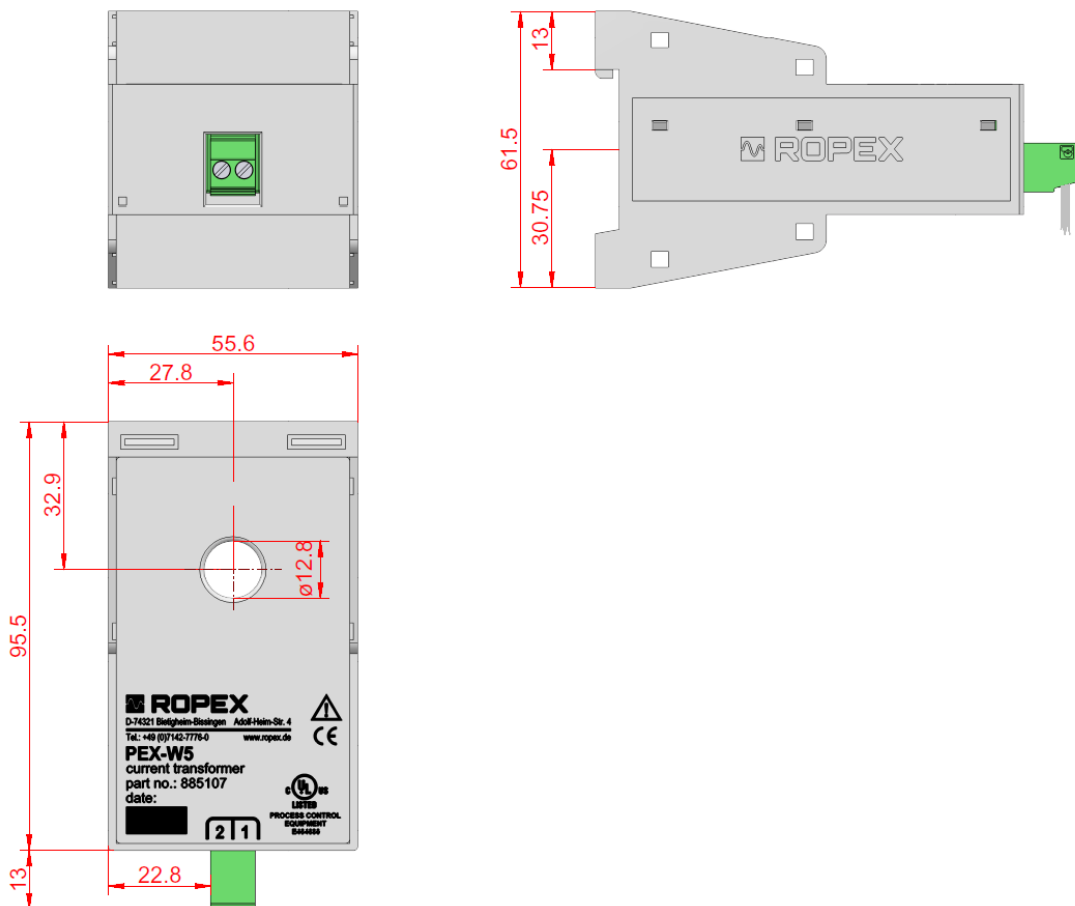
**7.5.1 PEX-W4**

**7.5.2 PEX-W5**

The current transformer is mounted on a hat rail measuring 35 x 7.5 mm or 35 x 15 mm in accordance with EN 60715.

If the high-current line cannot be conducted through the opening provided due to the diameter, an HCB-1 high-current rail must be used.

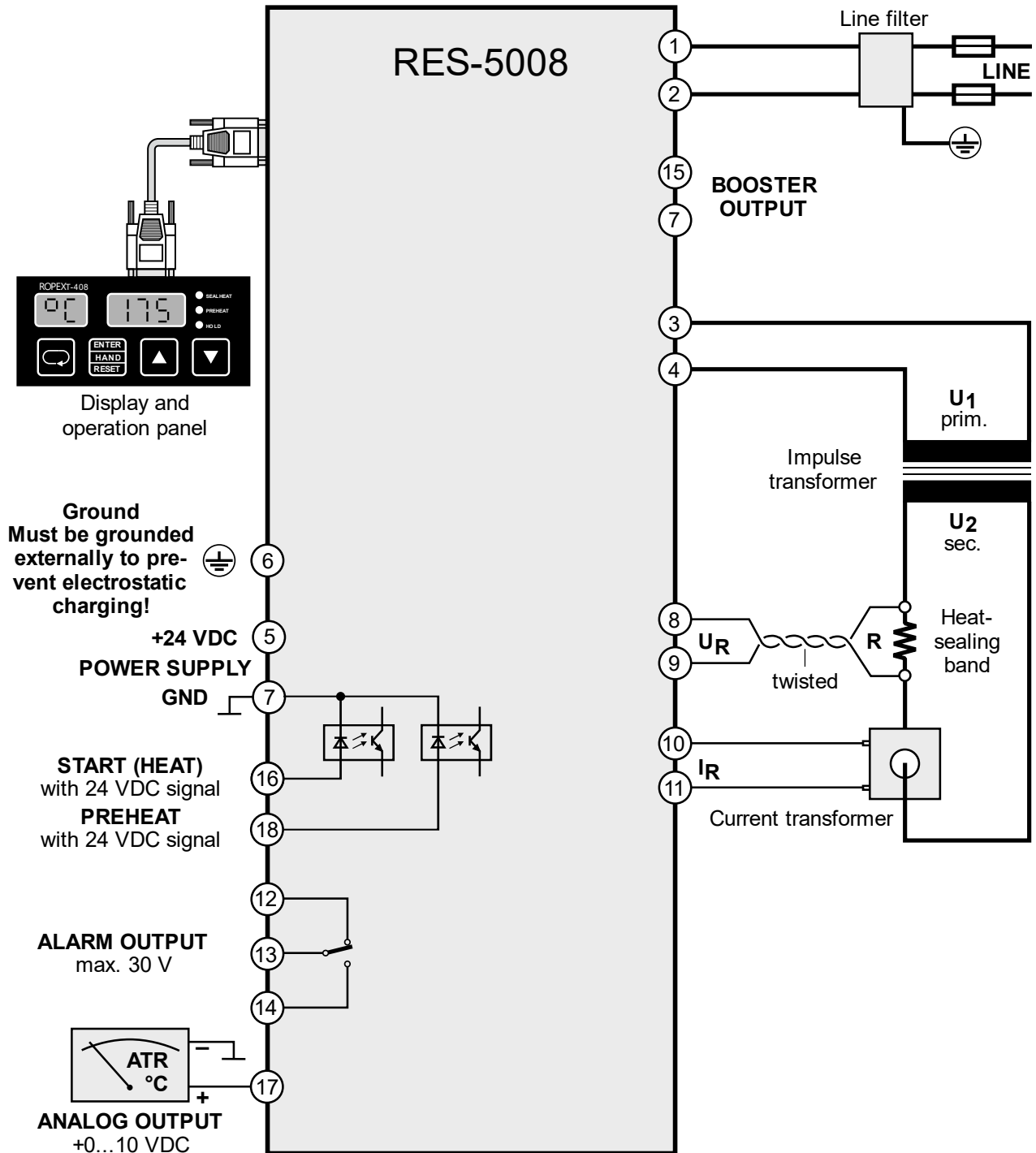
### 7.6 Circuit diagram (standard)



7.7 Circuit diagram with booster connection

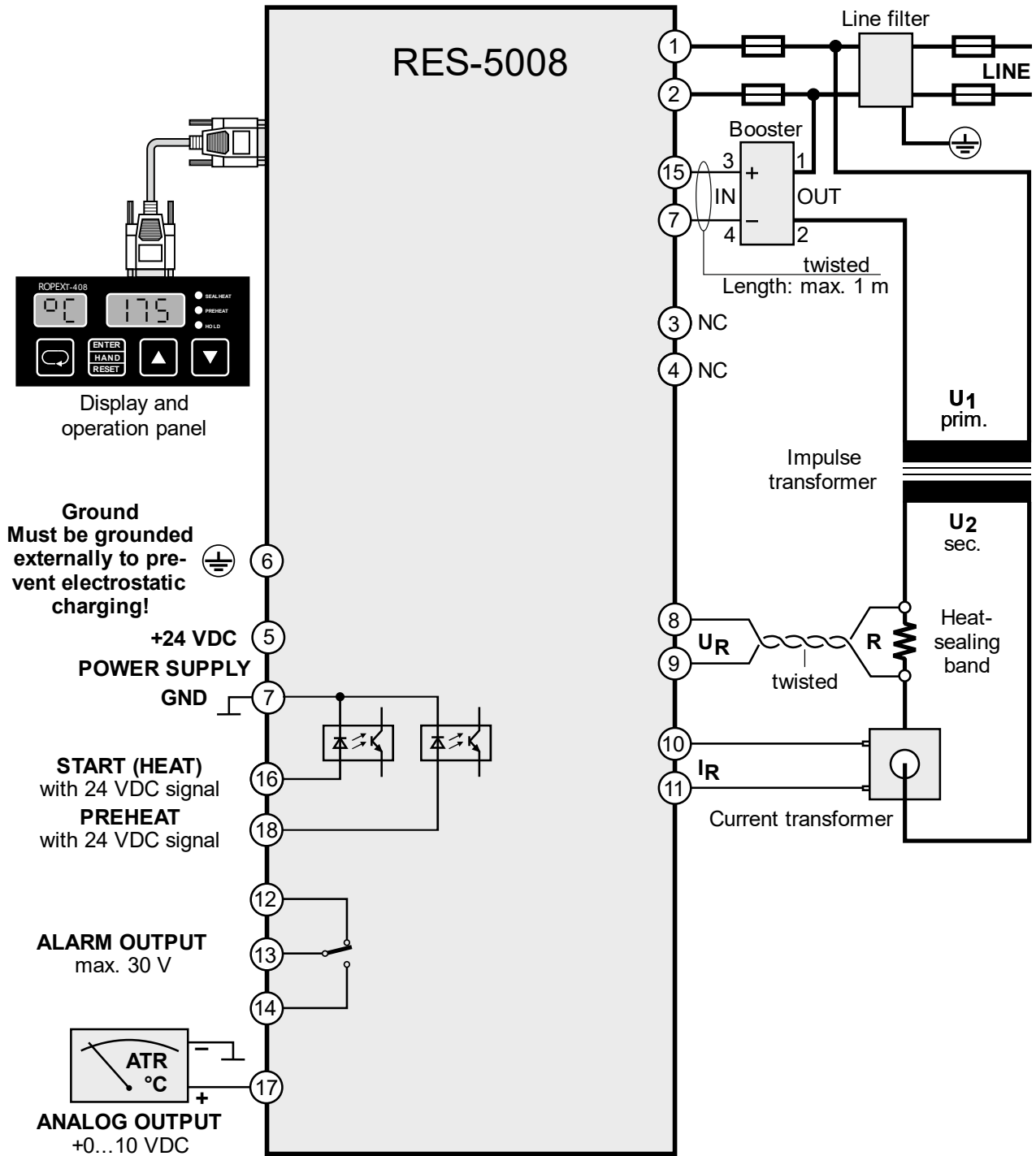

## 8 Commissioning and operation

### 8.1 Device view

RESISTRON® Temperature Controller RES-5008:

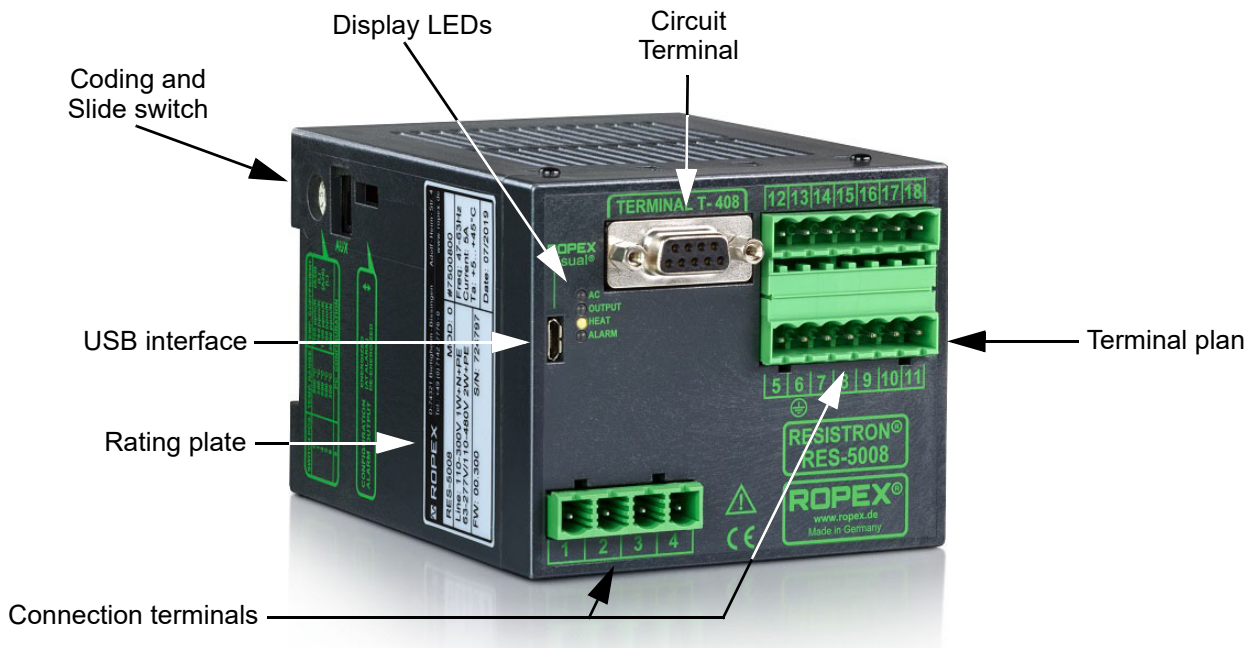

Terminal T-408-1:



### 8.2 Device configuration



#### NOTE

The regulator must be switched off to configure the coding switch and the slide switch.

### 8.2.1 Configuration of the ranges for secondary voltage and current

The ranges for secondary voltage and current are configured automatically when automatic calibration (AUTOCAL) is carried out. Configuration takes place in the voltage range of 0.4 VAC up to 120 VAC and in the current range from 30 A to 500 A. If voltage and/or current is outside the allowed range, a detailed error message is output by the regulator (↪ section 9.25 "Error messages" on page 50).

For secondary currents  $I_2$  less than 30 A, the secondary high-current line must be guided 2 times (or several times) through the transformer PEX-W4 or PEX-W5 (↪ ROPEX application report).



### 8.2.2 Configuration of the rotary coding switch for temperature range and alloy

Switch position	Temp. range	Temp. coefficient	Band alloy
0	300°C	1100ppm/K	e.g. A20
1	300°C	780ppm/K	e.g. L
4	500°C	1100ppm/K	e.g. A20
5	500°C	780ppm/K	e.g. L
8	300°C	3500ppm/K	
9	PC-CONFIGURATION		

↑  
0 = Factory settings

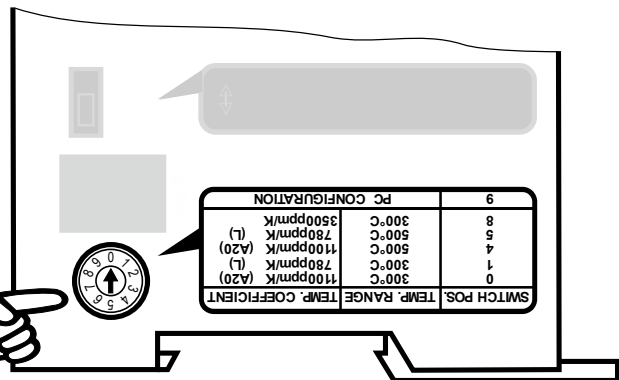

When the switch position "9" is selected, additional temperature ranges and alloys can be set through the ROPEX visualisation software (↪ section 9.22 "USB-interface for visualisation software ROPEXvisual<sup>®</sup>" on page 47).

### 8.2.3 Configuration of the alarm relay

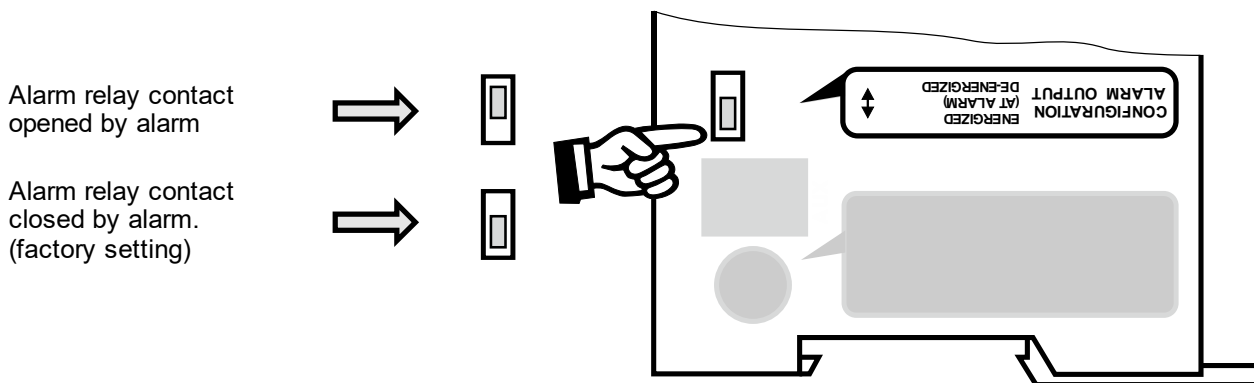

	<b>NOTE</b>
<p>ROPEX recommends the configuration “Alarm relay contact opened by alarm” in combination with contactor Kb to switch off the load in the event of a fault. As a result, the interruption of the wire (cable breakage) between the alarm relay of the RESISTRON<sup>®</sup> Temperature Controller and the alarm signal relay will be monitored.</p>	

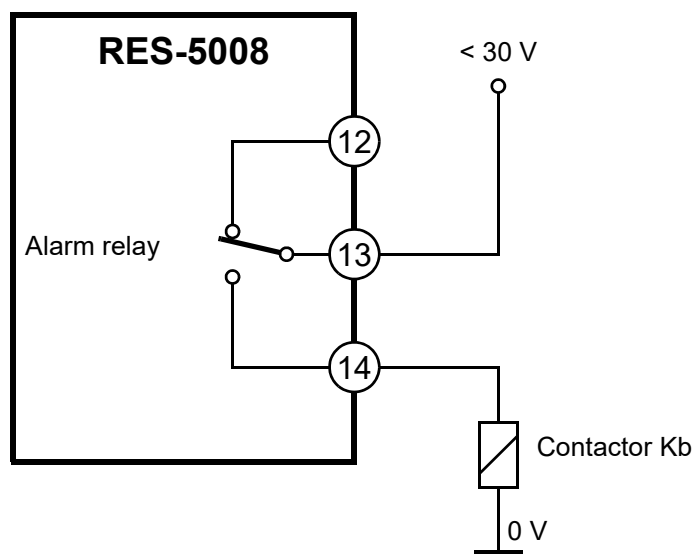

## 8.3 Burning in and changing the heating element

### 8.3.1 Burning in the heating element

The heating element is an important component in the control circuit, as it is both a heating element and sensor. Before using a heating element for the first time, please note the following.

#### Description of the burn-in effect:

When heating for the first time above 200 °C, some alloys (e.g. Alloy A20, Alloy L) experience a one-off change in the material properties (e.g. specific resistance).

The cold resistance of the heating element is reduced by about 2... 3 %. But this small change in resistance generates a zero point error of 20...30 K. Therefore the zero point must be corrected after heating the first time, i.e.,

the AUTOCAL function must be carried out again. To do this, the system (heating element, base, body, ...) must be cooled off completely.

After the first heating and renewed zeroing (AUTOCAL), the heating element is burned in and the change of resistance is stabilised. The heating element can now be used.

### Burn-in process:

It is carried out while the tool is open

1. Carry out AUTOCAL, so that the controller calibrates itself to the cold resistance of the heating element.
2. Heat the heating element to 250 °C, but at least 50 °C above the application-related sealing temperature.
3. Let the system (heating element, base, body, ...) cool down completely until the heating element temperature is stable.
4. Carry out AUTOCAL again so that the new cold resistance can be measured.

**8.3.2** The burn-in effect described here does not need to be considered if the manufacturer pre-treated the heating element for this purpose. The thermal pre-treatment is described as “burned in” at ROPEX in the article text. **Changing the heating element**

	<b>NOTE</b>
	If heating elements are used that have not been thermally pre-treated, the machine control (HMI) must enable the heating elements to be burned in.

	<b>⚠ WARNING</b>
	A damaged or burned out heating element may no longer be used due to irreversible changes in the material properties. This leads to a malfunction in the regulation.

	<b>NOTE</b>
	The heating element must be changed in accordance with the manufacturer’s instructions.

	<b>⚠ WARNING</b>
	For changing the heating element, the supply voltage must be disconnected RESISTRON® Temperature Controller RES-5008 at all phases.

ROPEX recommends changing the heating element in case of:

- mechanical defects, bending or deformations
- scaled or oxidised heating element ends
- burned-in deposits
- damaged coatings, e.g. copper coating or Teflon-coating



After each change of the heating element, the zeroing must be performed in case of cold elements and cold environment (i.e. silicone, PTFE-cover, sealing bar, among others) with the function AUTOCAL, in order to compensate production-related tolerances of the heating element resistances.



When changing the heating element, we recommend that the base is checked, for example silicone profile with PTFE-fabric band. A damaged base must be replaced to ensure that the heating element functions correctly.

If a new heating element is used, the above-described procedure for burning in must be performed.

If the new heating element has a different specification, it must be ensured that the voltage applied is adjusted to the resistance of the heating element. If the new heating element has another specification (e.g., heating element cross section, alloy), the application must be checked (↪ ROPEX-application report). If this specification was not taken into account in the application report, the application report must be updated in accordance with the new requirements.

### 8.4 Commissioning rules

Observe here section 3 "Safety" on page 5 and section 5.1 "Use" on page 11.

	 <b>WARNING</b>
	<p>The assembly, installation and commissioning may be performed only by technically trained and competent persons. The persons must be familiar with the dangers associated with it and guarantee provisions.</p>

#### 8.4.1 Initial commissioning

Requirement: Device is correctly mounted and connected (↪ section 6 "Transport and Storage" on page 13). Proceed as follows when commissioning the regulator RESISTRON® Temperature Controller RES-5008 for the first time:

1. Switch off mains voltage and 24 VDC power supply; verify lack of voltage.
2. Make sure that there is no 24 V-START signal present.
3. Switch on the mains voltage and 24 VDC power supply in any order.
4. After the voltage is switched on, the yellow "AUTOCAL" LED lights up for about 0.3 seconds and displays the correct switch-on process of the regulator. As long as no mains voltage is present, this LED blinks slowly (1 Hz).

	<b>NOTE</b>
	<p>In addition to the yellow LED "AUTOCAL", if the red LED "ALARM" lights up for 0.3 seconds, after switching on, the configuration with the visualisation software has been changed for this regulator (↪ section 9.22 "USB-interface for visualisation software ROPEXvisual®" on page 47). The regulator's configuration must be checked to avoid malfunctions before continuing with commissioning.</p>

5. The following statuses can then result:

"ALARM" LED	"OUTPUT" LED	MEASURE
OFF	Short pulses every 1.2 seconds	Continue with item 6
BLINKS quickly (4 Hz)	OFF	Continue with item 6
Permanently ON	OFF	Error diagnosis (↪ Chapter 9.25)

6. If the heating element is cold, please activate the function AUTOCAL at the Terminal T-408-1. During the adjustment process (approx. 10...15 seconds) the "AC" display flashes in the T-408-1 terminal's display.  
The yellow "AUTOCAL" LED lights up for the duration of the calibration process. During this calibration process, a voltage of approx. 0 VDC is output at the actual value output (terminals 17+7). A connected temperature display ATR-x shows 0...3 °C.  
After the zeroing has been carried out, the display of the T-408-1 terminal shows the home position again and the "AUTOCAL" LED goes out. A voltage of 0.66 VDC (in 300 °C range and Autocal temperature = 20 °C) or 0.4 VDC (in 500 °C range) is reached at the actual value output. A connected Temperature display ATR-x must be on the "Z" marking.  
If the zeroing is unsuccessful, a corresponding error message is shown on the display of the T- 408-1 terminal and the red "ALARM" LED blinks slowly (1 Hz). Then the configuration of the regulator is not correct (↪ section 8.2 "Device configuration" on page 21, ROPEX application report). After the device configuration is correct, perform zeroing again.
7. After successful zeroing, specify a defined temperature at the setpoint temperature and apply the START signal (HEAT). The "SEALHEAT" LED on the Terminal T-408-1 and the "HEAT" LED at the regulator light up. The actual temperature is shown on the display of the T-408-1 terminal. Thus, the heat-up and control procedure can be observed:  
The controller is functioning correctly if the temperature is constant, i.e., if it does not jump, oscillate or even briefly goes in the wrong direction. Such action indicates an incorrect placement of the  $U_R$  measurement line. When an error message is issued, proceed according to section 9.25 "Error messages" on page 50.
8. Burning in the heating element (↪ section 8.3 "Burning in and changing the heating element" on page 23) and repeat AUTOCAL function.

#### 8.4.2 Recommissioning after changing the heating element

While changing the heating element, proceed as per section 8.3 "Burning in and changing the heating element" on page 23.

	<b>⚠ WARNING</b>
Pay attention to correct alloys, dimensions and copper coating of the new heating element to avoid malfunctions and overheating.	

Continue with chap. 8.4.1 item 2 to item 8.

## 9 Device functions

See also section 7.6 "Circuit diagram (standard)" on page 19.

### 9.1 Display elements and operating elements

RESISTRON® Temperature Controller RES-5008:

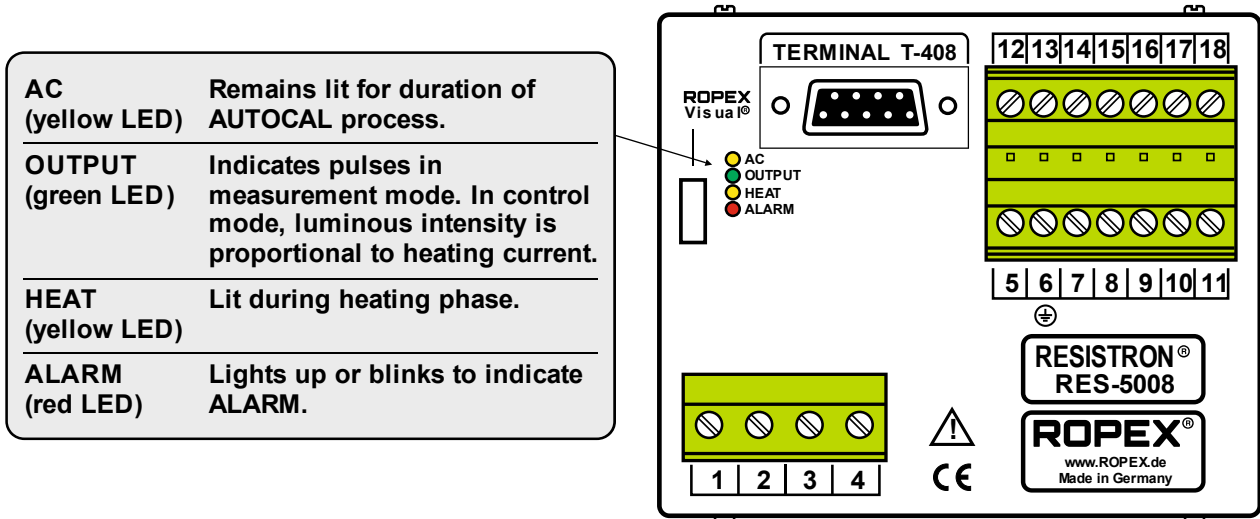

The LEDs display additional operating statuses of the regulator besides the functions in the above illustration. The operating states are shown in detail in the following table:

LED	Blinks slowly (1 Hz)	Blinks quickly (4 Hz)	On permanently
<b>AC (AUTOCAL)</b> (yellow)	Waiting for mains voltage	AUTOCAL requested, but function is blocked	AUTOCAL is carried out
	LED blinks with a different frequency: Incorrect (too low) supply voltage		
<b>OUTPUT</b> (green)	In control operation, the light intensity is proportional to the heating current.		
<b>HEAT</b> (yellow)	—	START requested, but function is blocked	START is carried out
<b>ALARM</b> (red)	Configuration error, AUTOCAL not possible	Regulator incorrectly calibrated, carry out AUTOCAL	Error, ↪ Chapter 9.25

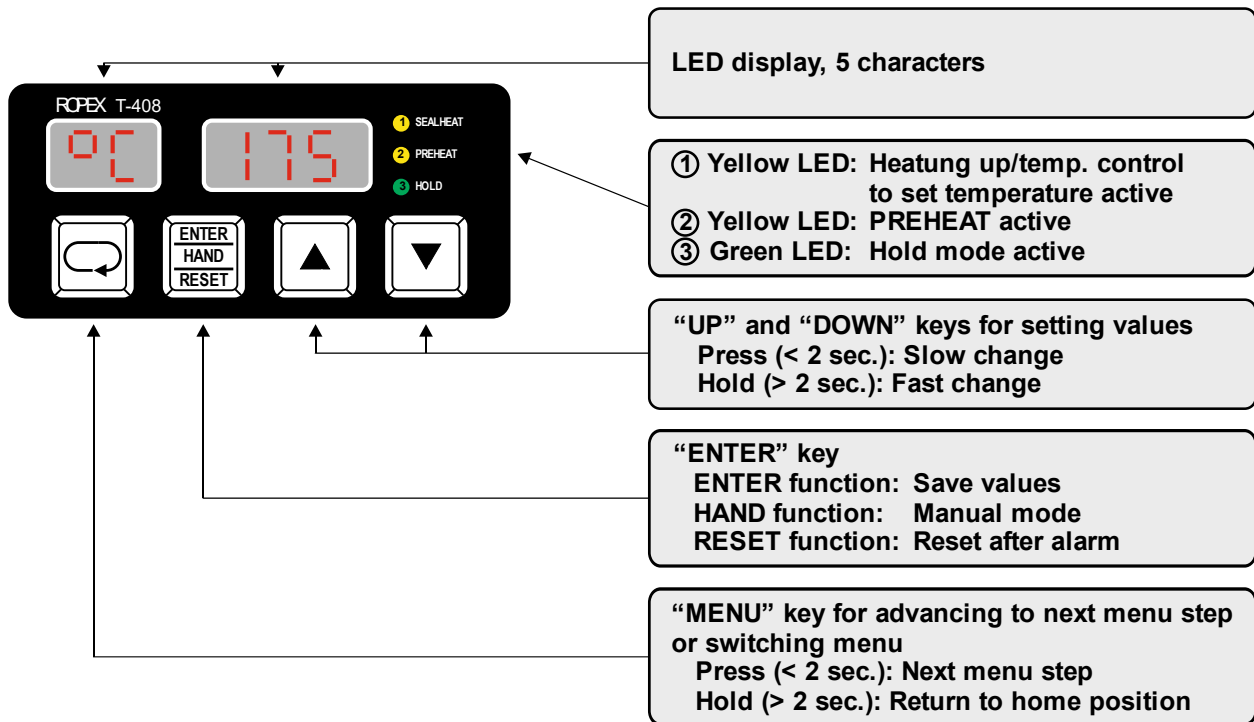
**Terminal T-408-1:**

## 9.2 Display image of the T-408-1 terminal

### 9.2.1 Switch-on message

After switching on the controller, a switch-on message is displayed for approx. 3 seconds. The message contains the firmware revision of the terminal for the first 1.5 seconds (for example: 00.105) and then the firmware revision of the controller (example: 00.300).

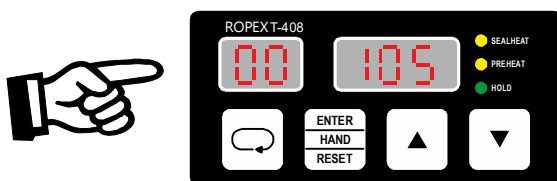

### 9.2.2 Display in home position

The display is in the home position “°C” and shows the ACTUAL temperature if no adjustments are made on the controller and if there are no error messages.

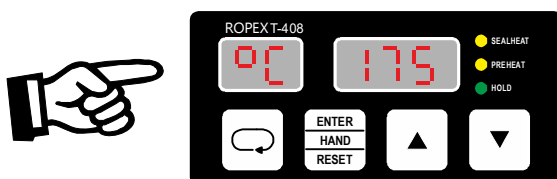

### 9.2.3 Settings menu

The required parameters are set in the Settings menu (↪ section 9.4 "Menu structure" on page 30)

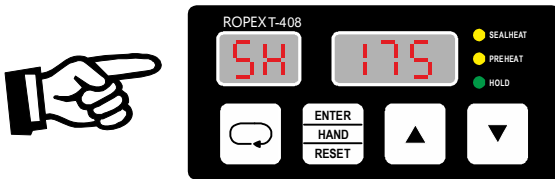

### 9.2.4 Error message

The fault diagnosis function of the controller is always active. A detected error is always reported in the form of an error message on the display (↪ section 9.24 "System monitoring/alarm output" on page 48).

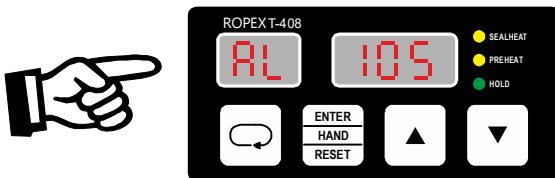

## 9.3 Menu navigation

### 9.3.1 Menu navigation without alarm

You can navigate through the various menu items using the "MENU" button.

- Briefly press (< 2 s) the "MENU" button to switch to the next menu item.
- Pressing the "MENU" button longer (> 2 s) always switches back to the home position. **Exception:** Controller is in alarm state. Then there is a return to the alarm menu.
- If no key is pressed for 30 s, there is a return to the home position **Exception:** There is no automatic return from the positions "AC" [AutoCal] and "AL" [ALarm] after waiting for 30 s.

### 9.3.2 Menu navigation in the event of an alarm

In the event of an alarm, the display on the terminal returns to the Alarm menu.

- Errors can be acknowledged by pressing the "RESET" button (↪ section 9.24 "System monitoring/alarm output" on page 48). The display then changes to the home position.
- Errors can be eliminated with the AUTOCAL function. By pressing the "MENU" key briefly (< 2 s) it is changed to the menu position "AC" [AutoCal] and the function AUTOCAL is started by pressing the "ENTER" key (↪ section 9.8 "Automatic zero calibration (AUTOCAL)" on page 34).

9.4 Menu structure

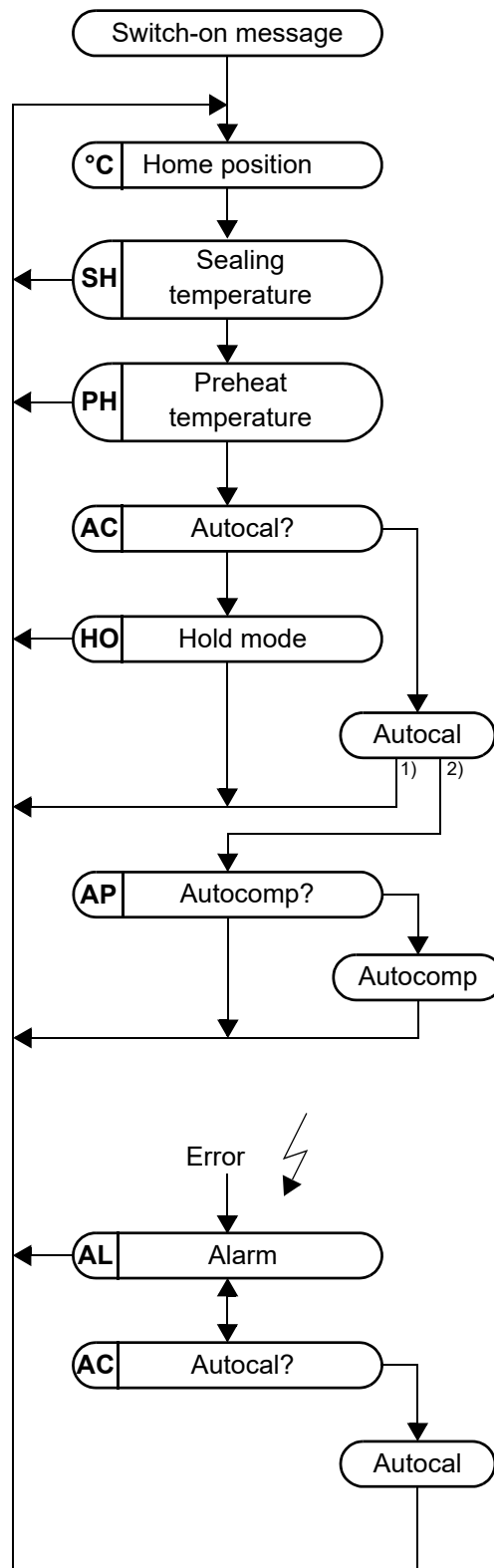

1) AUTOCOMP: OFF  
2) AUTOCOMP: ON

## 9.5 Menu items

	Labelling	Description	Adjustment range
°C	Home position	The current actual value is shown on the terminal's display. A manual heating process (to the adjusted sealing or preheating temperature) can be started by pressing the "HAND" button.	
SH	<b>[SealHeat]</b> Sealing temperature	The desired sealing temperature (setpoint value) can be set by pressing the "UP" and "DOWN" buttons. The maximum adjustable setpoint is limited by the rotary coding switch (alloy/range) and/or the PC visualisation software.	0, 40 °C...Maximum temp.
PH	<b>[PreHeat]</b> Preheating temperature	The desired preheating temperature PREHEAT can be set by pressing the "UP" and "DOWN" buttons. The maximum adjustable preheating temperature is limited by the rotary coding switch (alloy/range) and/or the PC visualisation software. Enter 0 °C to switch off the preheat function.	0, 40 °C...Maximum temp.
AC	<b>[AutoCal]</b> Automatic calibration AUTOCAL	With the AUTOCAL function, the controller adapts to the current signals and voltage signals present in the system. The controller is calibrated to the basic resistance of the heating element. The desired calibration temperature can be set with the "UP" and "DOWN" buttons. The set value is accepted with the ENTER key and the AUTOCAL function is started. "AC" flashes in the display. After calibration and the AUTOCOMP function switched off, the display changes directly to the home position. After successful calibration and activated AUTOCOMP function (setting "on"), it is switched to the menu item "AP". If the calibration cannot be carried out, the AUTOCAL process is cancelled. A corresponding error message appears.	0...40 °C
AP	<b>[AutocomP]</b> Automatic phase correction AUTOCOMP	The AUTOCOMP function is started with the ENTER key. If the ENTER key is not pressed within 2 s, there is a return to the home position. With the "AUTO" setting, AUTOCOMP starts automatically after successful calibration. The home position is automatically displayed after a successful AUTOCAL process and if the AUTOCOMP function is switched on.	

	Labelling	Description	Adjustment range
HO	<b>[HOLD]</b> Hold mode	By activating the Hold mode ("On"), the last measured value at the end of the heating phase is saved and shown on the display of the terminal. The active hold mode is indicated by the "HOLD" LED on the terminal. This process is repeated with each cycle and the displayed value is updated. If the "On2" function is selected, the display changes from Hold mode back to the actual value display in real time after 2 seconds. The hold function is only reactivated for 2 seconds at the end of the next cycle.	On On2 OFF
AL	<b>[ALarm]</b> Alarm menu	In the event of an alarm, the display on the terminal returns to the Alarm menu. Certain errors can be acknowledged by pressing the "RESET" button. The display then changes to the home position. In the event of errors that can be eliminated by executing the AUTOCAL function, you can switch to the "AC" [ <b>AutoCal</b> ] menu item by briefly pressing (< 2 s) the "MENU" button. The AUTOCAL function can be started there by pressing the "ENTER" key.	

## 9.6 Temperature setting (setpoint specification)

The setting of the sealing temperature is done in case of RESISTRON® Temperature Controller RES-5008 by adjusting in the menu position "SH" [**SealHeat**].

The setpoint specification for the welding temperature must be greater than 40 °C. If the setpoint specification is lower, no heating process takes place after activating the START signal or pressing the "HAND" button. The setting range 1...39 °C is not available.

## 9.7 Temperature display/Actual value output

If the display is in the basic position "°C", the ACTUAL temperature is shown.

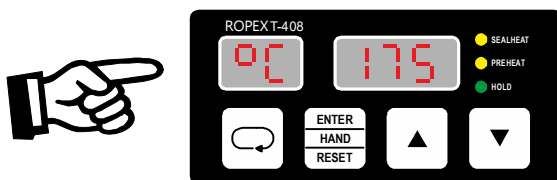

The heat-up and the control procedure can be observed through this.



In addition, the RESISTRON® Temperature Controller RES-5008 delivers an analogue signal 0...10 VDC at the terminals 17+7. The analogue signal is proportional to the real ACTUAL temperature.

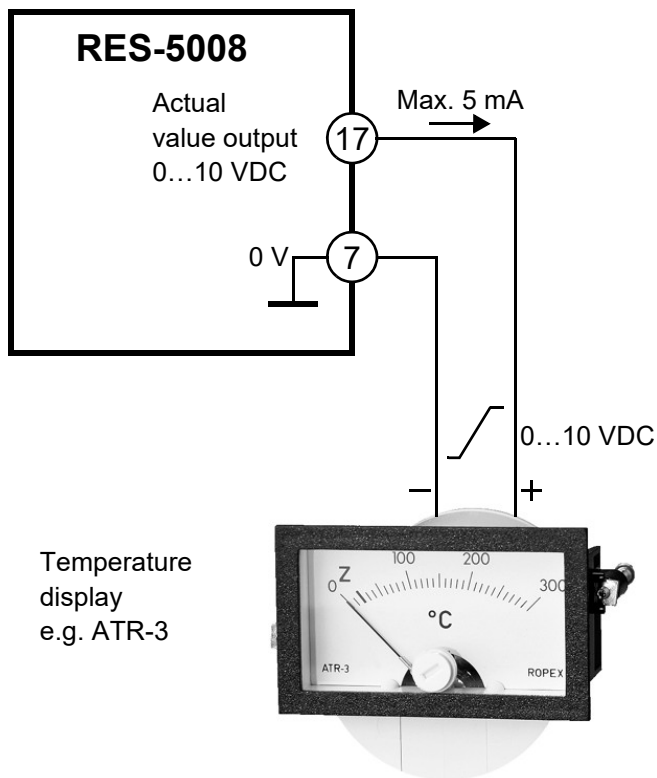

Voltage values:

0 VDC → 0 °C

10 VDC → 300 °C (ATR-3) or 500 °C (ATR-5), depending on the device configuration.

The correlation between the change in the output voltage and the ACTUAL temperature is linear.

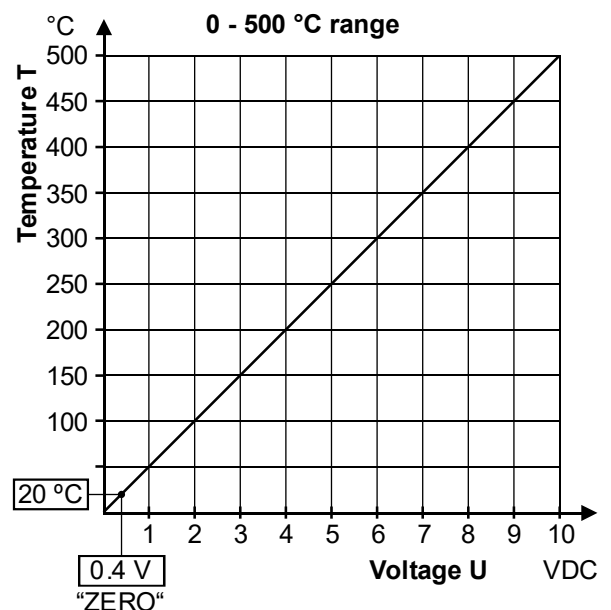
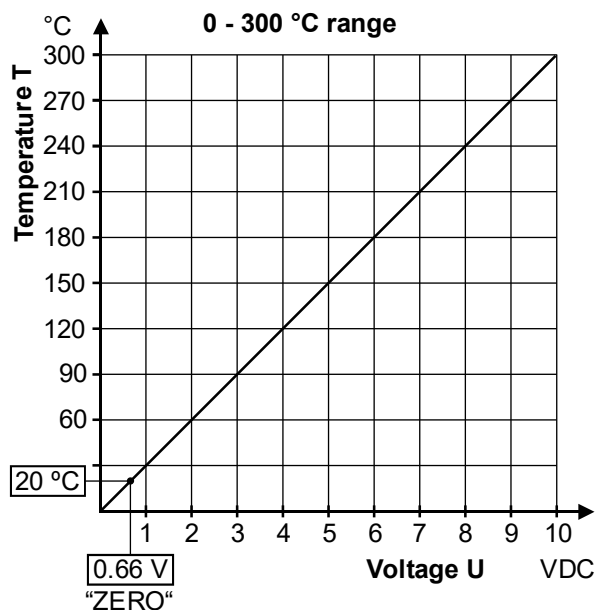

A display instrument can be attached to this analogue output for visualisation of the heating element temperature.

With this, not only SETPOINT-ACTUAL comparisons can be made, but also other criteria can be evaluated, such as heat-up speed, reaching the setpoint in the specified time, cooling of the heating element, etc.

Beyond that, malfunctions in the control circuit (loose contacts, contacting and wiring problems) and possibly mains faults can be observed very well at the display instrument. This applies also for mutual influencing of several neighbouring control circuits.

In addition to the display on the terminal, the analogue output can also be used to output differentiated error messages in the event of an alarm (↪ section 9.25 "Error messages" on page 50).

## 9.8 Automatic zero calibration (AUTOCAL)

With the AUTOCAL function, the controller adapts to the current and voltage signals present in the system. The controller is calibrated to the basic resistance of the heating element. This function is activated in the menu position "AC" [AutoCal] by pressing the "ENTER" key.

The basic temperature of the sealing bar (s) currently applicable for calibration can be set beforehand in the range 0...40 °C. This is done by pressing the "UP" and "DOWN" buttons.

In the factory setting, zeroing is carried out at the basic temperature of 20 °C.



### CAUTION

**In order to ensure that the seam quality remains constant, the set basic temperature for the calibration should correspond to the real ambient temperature.**

The automatic calibration process takes approx. 10...15 seconds and the yellow LED of the controller related to it, lights up. Additional heating of the heating element does not take place here. The actual value output (terminal 17+7) goes to 0...3 °C (i.e. approx. 0 VDC).

The AUTOCAL function is executed maximum 3 times, if the temperature of the heating element fluctuates. After that, if the function cannot be successfully ended, an error message is output (↪ section 9.25 "Error messages" on page 50).

The AUTOCAL function must be executed if the heating element has been changed or the wiring has been changed. In case the ambient temperature changes, there is no need calibrate again.



### CAUTION

**The AUTOCAL function must be enabled via the machine control (HMI). Otherwise, proper functioning cannot be guaranteed.**



### CAUTION

**Perform the AUTOCAL function only when the tool with the heating element has cooled off (basic temperature).**

### The AUTOCAL function is blocked:

- in the first 10 seconds after switching on the controller and the cooling speed of the heating element is less than 0.1 K/s.  
This is activated in the menu position "AC" [AutoCal] by pressing the "no1" key.
- if the cooling speed of the heating element is more than 0.1 K/s.  
This is activated in the menu position "AC" [AutoCal] by pressing the "no1" key.  
Note:  
If the AC bit is activated and the cooling speed has fallen below 0.1 K/s, the controller carries out the AUTOCAL function.
- if the START signal is activated.  
This is activated in the menu position "AC" [AutoCal] by pressing the "no2" key.
- if error numbers 101 to 103, 201 to 203 or 9xx occur directly after switching on the controller (↪ section 9.25 "Error messages" on page 50).

- if the controller has operated correctly at least once after being switched on and error numbers 201...203 or 9xx occur (↪ section 9.25 "Error messages" on page 50).
- if the line voltage is missing when switching on.  
If the controller is supplied with only 24 V, this is displayed in the menu position "AC" [AutoCal] by the additional message "no2".

## 9.9 Heating up to the sealing temperature (HEAT)

With the activation of the "START" signal (and the PREHEAT signal deactivated simultaneously), the device-internal target-actual comparison is enabled immediately and the heating element is heated up to the SETPOINT temperature. The heating takes place until the signal is switched off. This process can also be triggered independently of the START signal by pressing the "MANUAL" key, when the home position is displayed.

The "START" signal is activated through a 24 VDC signal to the terminals 16+7:

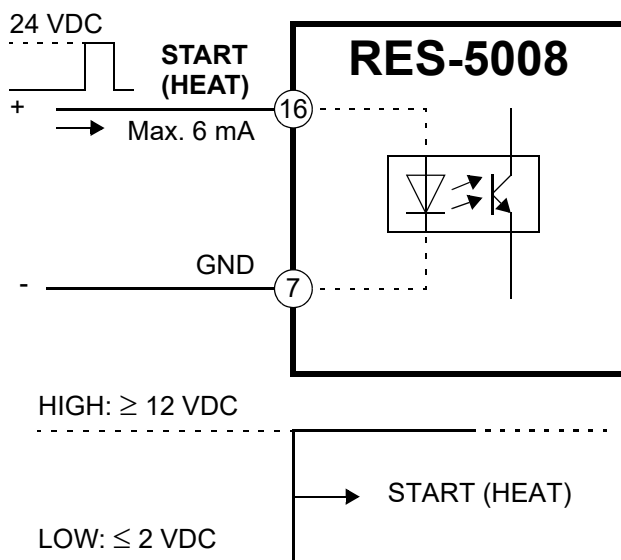

### CAUTION

The activation of the START signal is not accepted while the AUTOCAL function is being executed in the menu position "AC".

The setpoint specification for the sealing temperature (menu item "SH", [SealHeat]) must be greater than 40 °C. If the setpoint specified is lower, the heating process will not start. The setting range 1...39 °C is not available. The "SEALHEAT" LED on the T-408-1 terminal lights up during the heating and control process on the sealing temperature.

During a warning message with error nos. 104...105, 111...113, 211, the alarm relay is switched, when the START signal is activated (↪ section 9.25 "Error messages" on page 50). A heating process does not take place.



### CAUTION!

The PREHEAT-Signal (preheat) must be switched off during this heating and controlling process. Otherwise it will not be heated to the sealing temperature but instead to the set preheating temperature (↪ section 9.10 "Preheating (PREHEAT-Signal)" on page 36).

## 9.10 Preheating (PREHEAT-Signal)

In order to shorten the time for heating up to the adjusted SETPOINT temperature for applications for which time is critical, the heating element can be heated to a preheating temperature, with the PREHEAT function.

The preheating temperature is set in the menu item "PH" [PreHeat]. The specification for the preheating temperature must be greater than 40 °C. If the specification for the preheating temperature is lower, no heating process takes place after activating the START signal or pressing the "MANUAL" button. The setting range 1...39 °C is not available.

The PREHEAT signal is activated through a 24 VDC signal to the terminals 18+7.

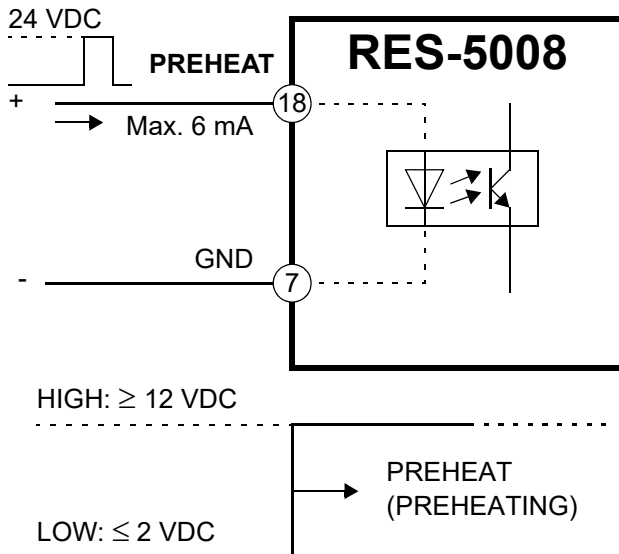

### CAUTION

The heating to the preheat temperature takes place when the START and PREHEAT signals are activated. The yellow PREHEAT LED on the T-408-1 terminal lights up.

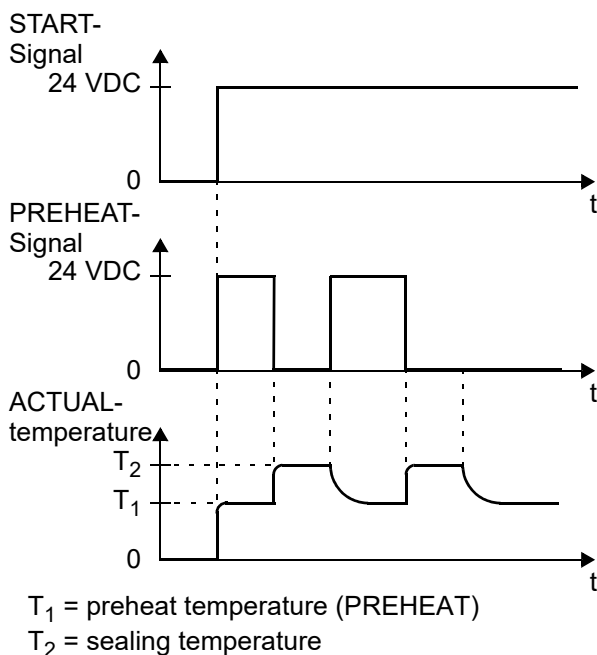

When the home position is shown on the terminal display, it is heated up to the set preheat temperature, while the "MANUAL" button is pressed and the PREHEAT signal is activated. Accordingly, the PREHEAT LED lights up.

## 9.11 Hold mode

If the display of the terminal T-408-1 is in the basic position “°C”, the ACTUAL temperature is indicated. The properties of the display for the ACTUAL temperature can be changed in the menu item “HO” [HOLD]. The following settings are possible:

1. **“OFF”** (factory setting)  
When the home position is shown in the display, the real ACTUAL temperature is always shown.
2. **“On”**  
When the home position is shown in the display, the current ACTUAL temperature at the end of the last sealing phase is always shown. After the regulator is switched on, the real ACTUAL temperature is displayed until the end of the first heating phase.
3. **“On2”**  
At the end of a sealing phase, the current ACTUAL temperature is displayed as a display value for another 2 seconds. Subsequently, the ACTUAL temperature is displayed in real time again up to the end of the next sealing phase.



### CAUTION

**The Hold Mode only affects the value shown on the display. The actual value output always shows the actual temperature in real time for all settings.**

The different Hold modes are depicted in the following image:

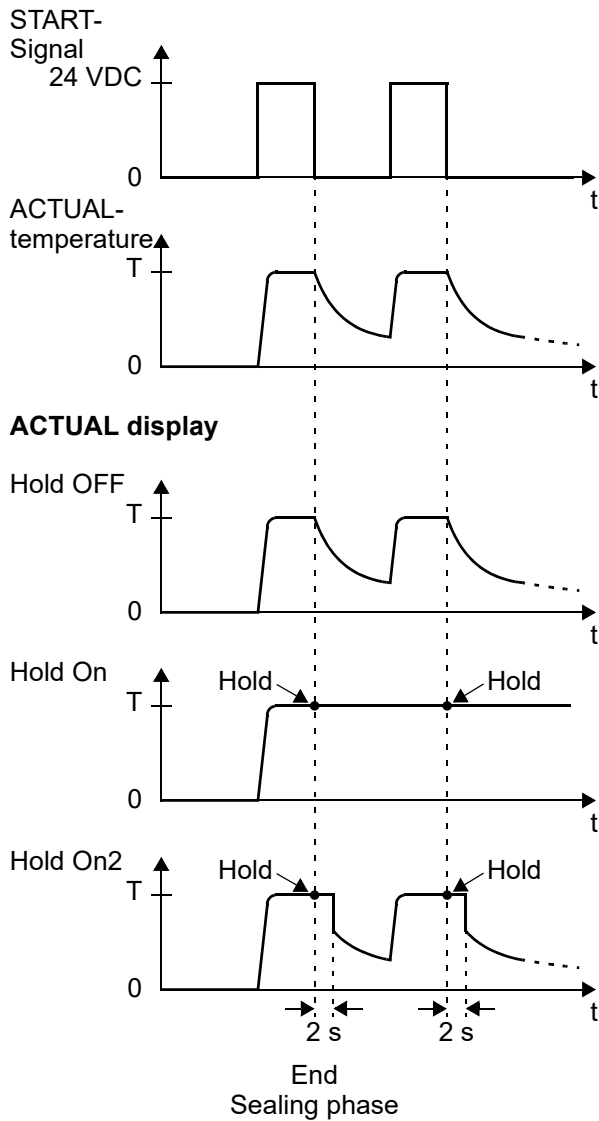

While the temperature value is displayed in Hold mode, the green "HOLD" LED at the terminal lights up.

### 9.12 Temperature unit Celsius/Fahrenheit

	<p><b>NOTE</b></p>
<p>The temperature unit can be changed while the RESISTRON<sup>®</sup> Temperature Controller RES-5008 is in operation.</p>	

The unit for the temperature display and temperature input can be switched between Celsius (°C) and Fahrenheit (°F). The display of the T-408-1 terminal must be in the home position.

The change is made by pressing the “UP” and “DOWN” buttons simultaneously. The buttons must be pressed for at least 2 seconds.

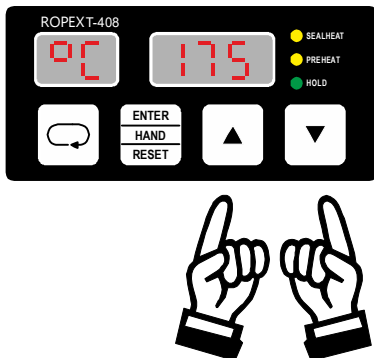

The following settings are possible:

1. **"Celsius"** (factory setting)  
The temperature display and the temperature input are made in the unit Celsius (°C).
2. **"Fahrenheit"**  
The temperature display and the temperature input are made in the unit Fahrenheit (°F)

	<b>NOTE</b>
If the temperature is displayed and entered in Fahrenheit (°F), the controller continues to function internally with the Celsius (°C) unit. When converting Celsius → Fahrenheit, there may be jumps in value for the temperature display and temperature input.	

### 9.12.1 TCR Calculator

	<b>NOTE</b>
The TCR Calculator is first available as from firmware version 301.	

The TCR-Calculator can be used to determine the temperature coefficient (TCR) of the heatsealing band used. The real temperature coefficient of the heatsealing band often differs from the standard value. The material composition and processing influence the properties of the heatsealing band. This leads to the fact that the temperature display of the controller differs from the real temperature of the heatsealing band. The usage of the TCR Calculator allows an easy correction of the TCR value and thus a better matching of the temperature display of the controller and the real temperature of the heatsealing band.

	<b>NOTE</b>
The user can only use the TCR Calculator with the ROPEX visualisation software (↪ Chapter 9.20 “USB interface for the visualisation software ROPEXvisual <sup>®</sup> ” on page 45).	

To calculate the TCR value, the temperature at the heatsealing band is measured in control mode (START signal active) using an external temperature sensor (e.g. a thermocouple). The measured temperature is transferred to the temperature controller by means of the ROPEX visualization software. The calculated temperature coefficient can be read off there. The temperature coefficient is only calculated in control mode (START signal active).



Reading back the calculated TCR value must be done during active control operation, i.e. during an active heating impulse, as the internal measured value of the current heatsealing band temperature is used for the calculation. Errors in the calculation of the temperature coefficient are reported with the value 0 (calculated temperature coefficient too low or no active control operation) or 65535 (calculated temperature coefficient too high).

To use the TCR calculator, proceed as follows:

1. The ROPEXvisual® visualization software must be unlocked with the password 'ropex3' under 'Settings' - 'Authorize'.
2. In the 'Controller' surface, the TCR calculator is opened with the 'TCR Calculator' icon button:

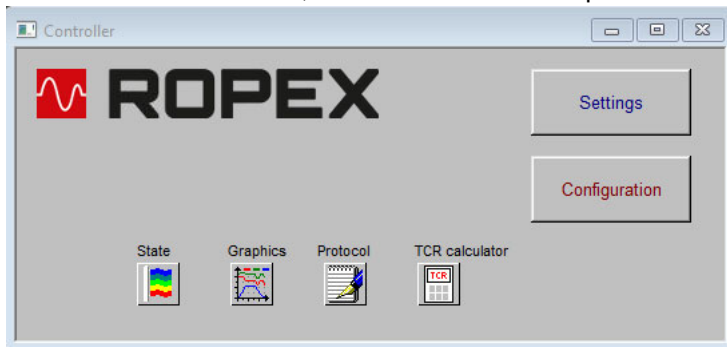

3. In this surface the externally measured temperature can be entered. During an active heating process, the calculated temperature coefficient is output:

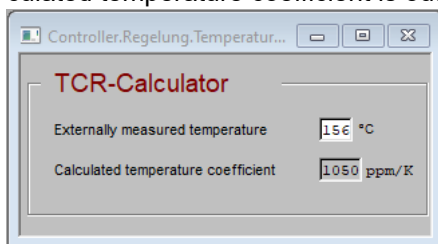

4. The variable temperature coefficient is set in the 'Configuration' surface. For this purpose, the rotary coding switch for temperature range and alloy on the RESISTRON® Temperature Controller RES-5008 must be set to position 9 PC-CONFIGURATION (↪ section 8.2.2 "Configuration of the rotary coding switch for temperature range and alloy" on page 22). After the temperature coefficient has been configured as 'variable', another input field for the temperature coefficient appears. The previously calculated temperature coefficient is entered here:

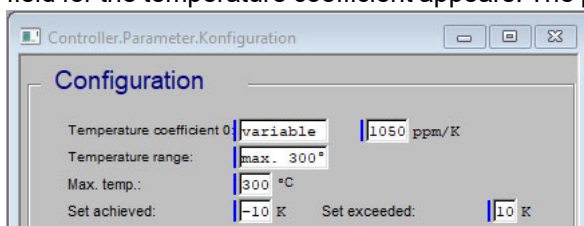

5. The elements marked in blue are stored retently in the RESISTRON® Temperature Controller RES-5008. The settings are thus retained even after a device restart.

### 9.13 Measurement impulse duration

The length of the measurement impulses generated by the controller can be set with the help of the measurement impulse duration. Generally speaking, the measuring pulse duration is 1.7 ms. For certain applications, it may be necessary to lengthen the measurement impulse (↪ ROPEX application report).



#### NOTE

The user can only set the measuring pulse duration with the ROPEX visualisation software (↪ Chapter 9.20 "USB interface for the visualisation software ROPEXvisual<sup>®</sup>" on page 45).

The measuring pulse extension can also be ordered as a modification from ROPEX (↪ section 15 "Modifications (MODs)" on page 62). The modification is then listed on the nameplate of the controller so that the technical change is visible.

### 9.14 Automatic phase correction (AUTOCOMP)

Default setting: AUTOCOMP off

The AUTOCOMP function can be activated for use with the ROPEX visualisation software (↪ section 9.22 "USB-interface for visualisation software ROPEXvisual<sup>®</sup>" on page 47).

In special sealing applications it may be necessary to counterbalance the phase shift between the  $U_R$  and  $I_R$  measurement signals, e.g. in case of very low-resistance short heating elements or heating elements with magnetic properties. The phase correction is executed with the “AUTOCOMP” function.

The following settings are possible:

1. “Off” (factory setting)

AUTOCOMP function switched off.

2. “On”

After the AUTOCAL (↵ section 9.8 "Automatic zero calibration (AUTOCAL)" on page 34) function has been executed successfully, the AUTOCOMP function is carried out by pressing the ENTER key. The ENTER key must be pressed within 2 seconds after the end of the AUTOCAL function. Within these 2 seconds, the “AP”[AutocomP] is shown in the display of the terminal and the three decimal points light up. The subsequent execution of AUTOCOMP lasts only for approx. 2 seconds. (In doing so, “AP” is shown in the display of the terminal and the three decimal points light up one after the other).

If the ENTER key is not pressed within 2 seconds after AUTOCAL has been successfully executed, there will be a return to the home position. The AUTOCOMP function is not executed.

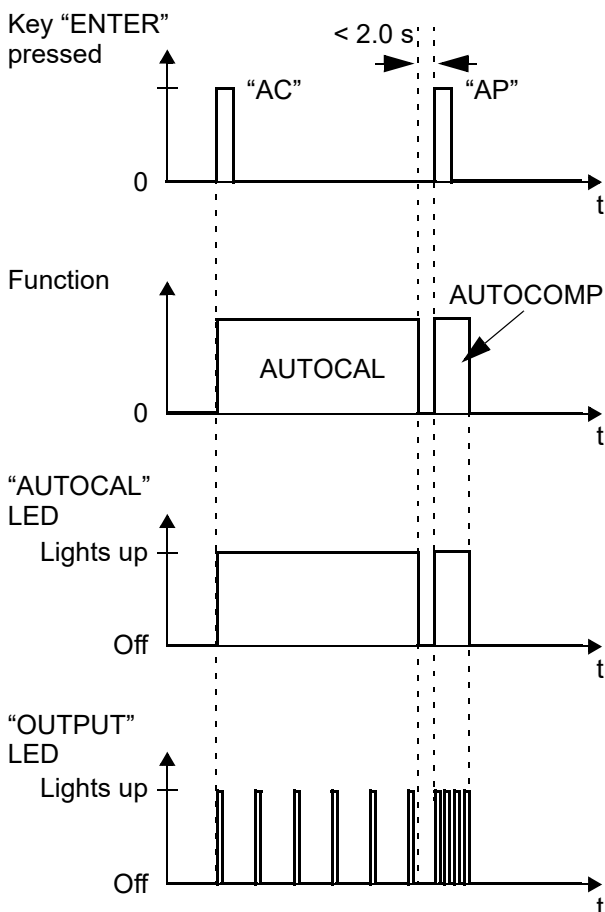

While executing the function AUTOCOMP, the “OUTPUT” LED blinks several times and the actual value output (terminals 17+7) goes to 0...3 °C (i.e. approx. 0 VDC).

3. “AUTO”

With this setting, the AUTOCOMP function is automatically started after a successful execution of the AUTOCAL function.

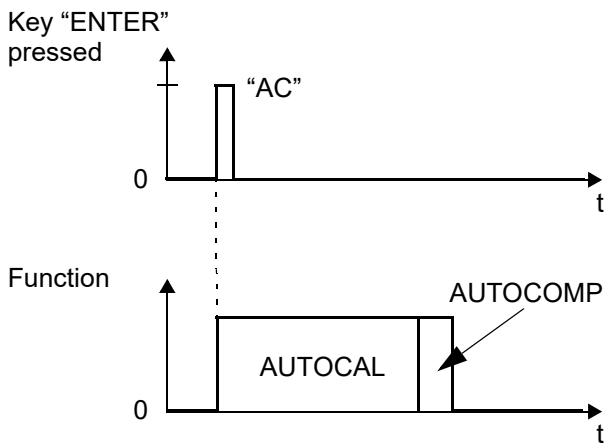

While executing the function AUTOCOMP, the "OUTPUT" LED blinks several times and the actual value output (terminals 17+7) goes to 0...3 °C (i.e. approx. 0 VDC).

### 9.15 Temperature diagnosis

An additional temperature diagnosis can be activated with the ROPEX visualisation software (↪ section 9.22 "USB-interface for visualisation software ROPEXvisual<sup>®</sup>" on page 47). The RESISTRON<sup>®</sup> Temperature Controller RES-5008 checks if the ACTUAL temperature within an settable tolerance band "OK window" is found on either side of the SETPOINT temperature. The lower ( $\Delta\vartheta_{lower}$ ) and upper ( $\Delta\vartheta_{upper}$ ) tolerance band limit are set at the factory to -10 K and +10 K, respectively. These values can be set separately from each other with the ROPEX visualisation software.

After activation of the START signal, if the ACTUAL temperature is found within the specified tolerance band, the temperature diagnosis is switched on. If the ACTUAL temperature leaves the tolerance band, the related error nos. 307, 308 are output and the alarm output switches on (↪ section 9.25 "Error messages" on page 50).

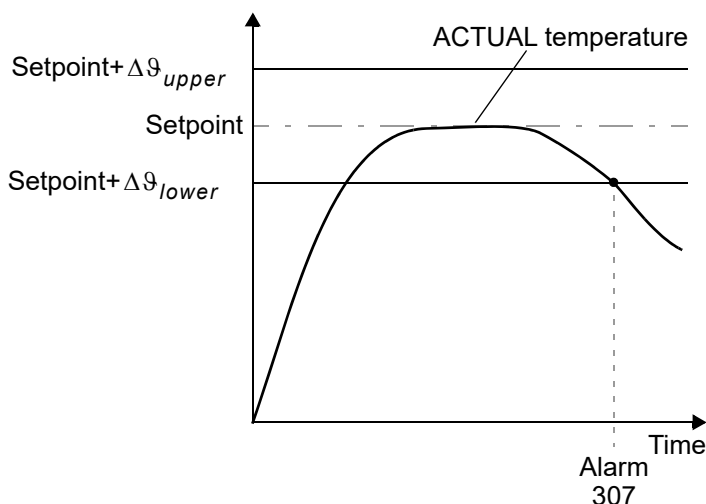

If the temperature diagnosis has not been activated before the START signal is deactivated (i.e. the ACTUAL temperature has not exceeded the lower tolerance band limit or has not dropped below the upper tolerance band limit), the related error nos. 309, 310 are output and the alarm relay switches on.

A delay time (0...9.9 sec.) can also be set with the ROPEX visualisation software. After the lower tolerance band limit is exceeded, the temperature diagnosis takes place only after the parametrised delay time has expired. As a result, the temperature diagnosis can be intentionally suppressed, e.g. during a temperature drop caused by closing the tool.

## 9.16 Heat-up time monitoring

An additional heat-up time monitoring can be activated with the ROPEX visualisation software (↪ section 9.22 "USB-interface for visualisation software ROPEXvisual<sup>®</sup>" on page 47).

The heating-up time monitoring is activated when the START signal is switched on. The RESISTRON<sup>®</sup> Temperature Controller RES-5008 then monitors the time till the ACTUAL temperature reaches 95 % of the SETPOINT temperature. If the heating-up time takes longer than the parametrised time, error no. 304 is output and the alarm output switches on (↪ section 9.25 "Error messages" on page 50).

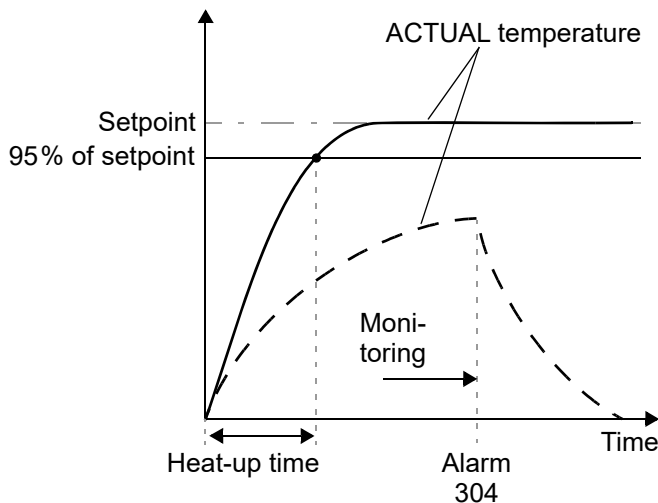

Possible causes for the response of the heating-up time monitoring:

- Impulse transformer incorrectly dimensioned
- Heating-up time monitoring parametrisation too small
- Lines too long or defective
- Incorrect contact

## 9.17 Restart delay after Reset

After acknowledging an alarm with the RESET signal, the RESISTRON<sup>®</sup> Temperature Controller RES-5008 waits until any contactor Kb connected has closed the heating circuit again. Only after this waiting time has elapsed measuring pulses are generated in order to determine the current ACTUAL temperature and to carry out error diagnostics.



### NOTE

The user can only set the restart delay after Reset with the ROPEX visualisation software (↪ Chapter 9.20 "USB interface for the visualisation software ROPEXvisual<sup>®</sup>" on page 45).

This restart delay is 0.2 s by default and can be adjusted with the parameter „Restart delay after Reset“. This allows slower switching contactors to be used.

## 9.18 Maximum measurement pause

If the RESISTRON® Temperature Controller RES-5008 determines in control mode (START signal active), that the current ACTUAL temperature is greater than the setpoint, the power supply to the heatsealing band is reduced. If the power reduction is not sufficient, the low-power measuring pulses, which determine the current ACTUAL temperature, are paused. This measurement pause can last up to 10 periods in the default setting. During this measurement pause, the controller cannot react to a change in the ACTUAL temperature.

In certain applications it may be useful to shorten this maximum measurement pause, e.g. if the higher ACTUAL temperature values are caused by measurement errors. For these cases the maximum measuring pause can be shortened with the parameter „Maximum measurement pause“.



### NOTE

The user can only set the maximum measurement pause with the ROPEX visualisation software (↪ Chapter 9.20 “USB interface for the visualisation software ROPEXvisual®” on page 45).



### CAUTION

A measuring pause that is set too small can lead to an increased temperature if the system is incorrectly dimensioned (secondary voltage of the impulse transformer is too large) or if the sealing temperatures are low.

## 9.19 Communication failure between controller and terminal

If the data communication between RESISTRON® Temperature Controller RES-5008 and the T-408-1 terminal is disrupted or interrupted, this is shown by a special display (rotating display segments) on the terminal's display.

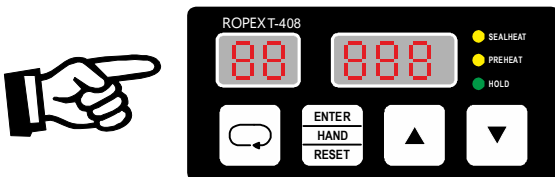

The following options are included as reasons for a communication disorder:

- Defective connection cable between controller and terminal.
- Hardware defect in controller and/or terminal.



### CAUTION

The RESISTRON® Temperature Controller RES-5008 continues to work in case there is a communication failure. No error message is output, the alarm relay is not active. To avoid malfunctions, the controller must be switched off immediately.

## 9.20 Undervoltage detection

The flawless function of the RESISTRON® Temperature Controller RES-5008 is guaranteed for tolerance range of the mains voltage specified in the section 13 "Technical data" on page 59.

If the 24 VDC supply voltage falls below the permitted tolerance range, the RESISTRON<sup>®</sup> Temperature Controller RES-5008 switches to a standby mode. Sealing processes and measuring impulses are no longer carried out. This is shown by a special message on the display.

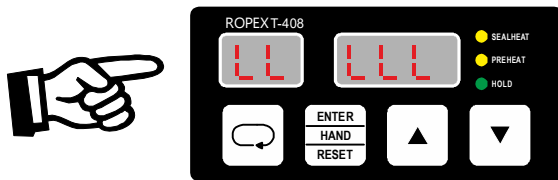

When the input voltage is found again within the specified tolerance range, the basic menu is displayed again and the operation continues.

0 °C (i.e. 0 V) is output at the analogue output, as an indication of standby status. The alarm relay is not active.

	<b>⚠ WARNING</b>
	The proper function of the RESISTRON <sup>®</sup> Temperature Controller RES-5008 is guaranteed only within the specified tolerance range of the input voltage. An external voltage monitoring device must be used to avoid faulty seals, if the mains or the 24 VDC supply voltage is too low.

### 9.21 Booster connection

Normally, the RESISTRON<sup>®</sup> Temperature Controller RES-5008 has a connection for an external switching amplifier (booster). This connection of an external switching amplifier (at the terminals 15+7) is required at high primary currents (constant current > 5 A, impulse current > 25 A). The switching amplifier must be connected in accordance with section 7.7 "Circuit diagram with booster connection" on page 20.



#### CAUTION

In order to avoid the EMC interference, the connection cable to the external switching amplifier may not exceed a length of 1 m and has to be twisted.

### 9.22 USB-interface for visualisation software ROPEXvisual<sup>®</sup>

A USB interface (type micro-USB) is available for system diagnosis and process visualisation. A data connection can be built up with the ROPEX visualisation software ROPEXvisual<sup>®</sup> over this USB interface.

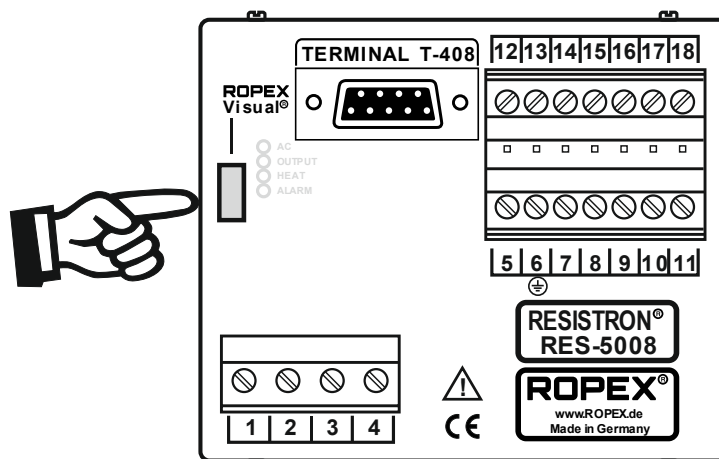

With the ROPEX visualisation software ROPEXvisual<sup>®</sup> the following may happen

- Error messages may be read out
- Temperature curves may be recorded
- Status bits may be displayed
- Parameters may be set
- Manual triggering of sealing pulses can be generated during startup

The ROPEX-Visualisation software ROPEXvisual<sup>®</sup> is intended for startup and the error diagnosis. Permanent records of the sealing parameters cannot be created with this. The recording of the sealing parameters or status bits must be done within the machine control. A separate document is available for the ROPEX-visualisation software ROPEXvisual<sup>®</sup>. The software and the documentation are available in the [download area](#) (search term: "Visual").

### 9.23 AUX interface

Internal interface for diagnosis and maintenance. The interface is currently not available.

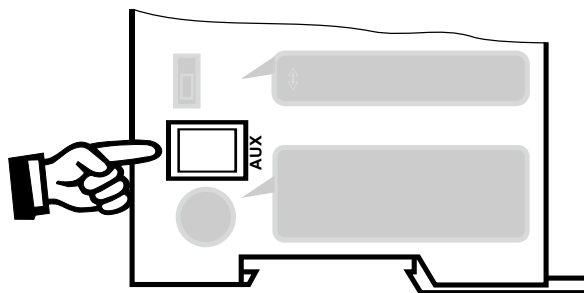

### 9.24 System monitoring/alarm output

To increase the operational safety and to avoid incorrect seals, the RESISTRON<sup>®</sup> Temperature Controller RES-5008 has a differentiated error message and diagnosis. Both the outer wiring and the internal system are monitored by hardware and software measures. The system monitoring supports the operator in localising a defective operating status.

A system malfunction is reported or differentiated through the following elements.

#### A.) Terminal T-408-1: Display of an error message in the display of the terminal:

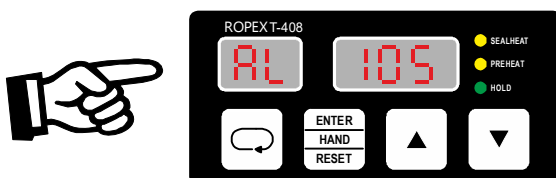

The cause of the fault can be localised quickly and easily through the displayed error number. A list of the possible error numbers is included in section 9.25 "Error messages" on page 50.

#### B.) RESISTRON<sup>®</sup> Temperature Controller RES-5008: Red LED "ALARM" on the controller (↪ section 9.1 "Display elements and operating elements" on page 27) with three states:



### 1. **Blinks quickly (4 Hz):**

The AUTOCAL function must be carried out  
(Error Nos. 8 + 9, or 104...106, 211, 302, 303)

### 2. **Blinks slowly (1 Hz):**

System configuration is not correct and therefore the zeroing (AUTOCAL function) carried out was not successful (↪ section 8.2 "Device configuration" on page 21).  
(Error nos. 10...12, or 111...114)

### 3. **Lights up continuously:**

Faults prevent commissioning  
(Error nos. 101...103, 107, 108, 201...203, 307...310, 9xx)  
In cases 1 and 2, when START signal is also activated.  
These are usually external wiring errors.

## C.) **Alarm relay (relay contacts of terminals 12+13+14):**

In the factory setting, the alarm relay is:

- **NOT ACTIVE** in the operating states "Blinks quickly" (B.1) or "Blinks slowly" (B.2). The alarm relay is activated, however, if a START signal is given in one of these states.
- **ACTIVE** in the operating state "lights up continuously" (B.3).



### CAUTION

If the alarm relay is configured differently than in the factory setting (↪ section 8.2.3 "Configuration of the alarm relay" on page 23) these statuses are inverted.

## D.) **Output of the error number via the actual value output 0...10 VDC (terminals 17+7):**

As a temperature display is not required in case of malfunction, the actual value output is used to output the error, in case of alarm.

- 13 voltage levels are available within the 0...10 VDC range.  
An error number is assigned to every voltage level (↪ section 9.25 "Error messages" on page 50).
- In case of error nos. 104...106, 211, 302, 303 (AUTOCAL must be carried out) and in case of error nos. 111...114, (system configuration is not correct) the actual value output alternates between the voltage value that corresponds to the error and the final value (10 VDC, i.e. 300 °C or 500 °C) with 1 Hz. If the START signal is given, the voltage value does not change any more.
- An error message can be reset by applying the "RESET" signal or switching the controller off and on. The error message is reset only when the button is released.

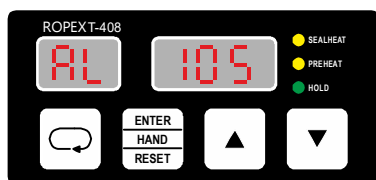

Invalid error messages can occur when the controller is switched off due to the undefined operating status. This must be taken into account while evaluating the higher-level controller (e.g. SPS), to avoid false alarms.

## 9.25 Error messages

The following table shows the assignment of the output error numbers to the errors that occur. The cause for the errors and the necessary measures to remedy them are described.

The schematic circuit diagram in section 9.26 "Error areas and causes" on page 55 permits fast and efficient error remedy.

The RESISTRON® Temperature Controller RES-5008 displays 13 voltage levels for error diagnosis via the actual value output. Internally in the regulator, the error messages are differentiated in even more detail. 3-digit error numbers are also displayed with the ROPEX-Visualisation software (↪ section 9.22 "USB-interface for visualisation software ROPEXvisual®" on page 47). The error search can thus be performed even more effectively.



### **CAUTION**

**Evaluation of the actual value output for detection of an error message has to be done - e.g. in the higher-order controller – with an adapted tolerance window, to avoid incorrect evaluations. The tolerances of the actual value output must be observed (↪ section 13 "Technical data" on page 59).**

**Part 1 of 3: Error messages (faults)**

**NOTE:** The specified error messages are output as faults:

- Actual value output displays constant error voltage
- Alarm LED lights up continuously
- Alarm relay is active

Error no.	Actual value output Voltage [V]	Cause	Measure during initial startup	Measure during machine operation, heating element not changed	
1	101	0.66	Current signal missing	Error range ①	Error range ①
2	102	1.33	Voltage signal missing	Error range ③	Error range ③
3	103	2.00	Voltage and current signals missing	Error range ②	Error ranges ②⑨
4	107	2.66	Temperature step, down	Error ranges ④⑤⑥ ("Loose contact")	Error ranges ④⑤⑥ ("Loose contact")
	108		Temperature step, up		
	307		Temperature too low, leave the tolerance band (↪ Chap. 9.15)	Check the dimensioning of the impulse transformer, Check heat removal through the sealing process, Verify application through sealing tests	-
	308		Temperature too high, leave tolerance band (↪ Chap. 9.15)		
	309		Temperature too low, tolerance band not reached (↪ Chap. 9.15)		
	310		Temperature too high, tolerance band not reached (↪ Chap. 9.15)		
5	201	3.33	Line frequency missing/fluctuates	Check power supply: Line frequency Harmonic waves Voltage fluctuations	Check power supply: Line frequency Harmonic waves Voltage fluctuations
	202		Line frequency too high/fluctuates		
	203		Line frequency too low/fluctuates		
6	304	4.00	Heat-up time too long (↪ Chap. 9.16)	Perform <b>RESET</b> Check the dimensioning of the pulse transformer, Verify the parametrised heating time, Check wiring and contacts	Perform <b>RESET</b> Check wiring and contacts, Verify the sealing process

**Part 1 of 3: Error messages (faults)**

**NOTE:** The specified error messages are output as faults:

- Actual value output displays constant error voltage
- Alarm LED lights up continuously
- Alarm relay is active

Error no.		Actual value output Voltage [V]	Cause	Measure during initial startup	Measure during machine operation, heating element not changed
7	901	4.66	Line voltage/synchronising signal missing	Replace device	Replace device
	913		Triac defective	Replace device	Replace device
	914		Int. error, device defective	Replace device	Replace device
	915				
	916				
	917		Incorrect slide switch for alarm output	Check slide switch	Check slide switch
918					

**Part 2 of 3: Error messages (warnings)**

**NOTE:** The specified error messages are first output as warnings:

- Actual value output changes between two values
- Alarm LED blinks quickly
- Alarm relay is not active

After activation of the START signal, the output occurs as a fault:

- Actual value output does not change any more, see bold italic values
- Alarm LED lights up continuously
- Alarm relay is active

Error no.	Actual value output Voltage [V]	Cause	Measure during initial startup	Measure during machine operation, heating element not changed
8	104	Current signal incorrect Impulse transformer incorrectly dimensioned	Perform <b>AUTOCAL</b> , Check transformer specification, Error ranges ⑦ ⑧	Error ranges ④ ⑤ ⑥ ("Loose contact")
	105	Voltage signal incorrect Impulse transformer incorrectly dimensioned Strong harmonic waves on mains supply		
	106	Voltage and current signal incorrect Impulse transformer incorrectly dimensioned		
	302	Temperature too low Calibration not performed Loose contact Ambient temperature fluctuates	Perform <b>AUTOCAL</b> and/or Error ranges ④ ⑤ ⑥ ("Loose contact")	
	303	Temperature too high Calibration not performed Loose contact Ambient temperature fluctuates		
9	211	Data error	Perform <b>AUTOCAL</b>	Perform <b>AUTOCAL</b>

**Part 3 of 3: Error messages (warnings)**

**NOTE:** The specified error messages are first output as warnings:

- Actual value output changes between two values
- Alarm-LED blinks slowly
- Alarm relay is not active

After activation of the START signal, the output occurs as a fault

- Actual value output does not change any more, see bold italic values
- Alarm LED lights up continuously
- Alarm relay is active

Error no.		Actual value output Voltage [V]	Cause	Measure during initial startup	Measure during machine operation, heating element not changed
10	111	<i><b>6.66</b></i> ↔ 10 ↔	Current signal incorrect, Calibration not possible	Error range ⑧ Check configuration	Error ranges ④ ⑤ ⑥ ("Loose contact")
11	112	<i><b>7.33</b></i> ↔ 10 ↔	Voltage signal incorrect, Calibration not possible	Error range ⑦, Check configuration	Error ranges ④ ⑤ ⑥ ("Loose contact")
12	113	<i><b>8.00</b></i> ↔ 10 ↔	Voltage/current signal incorrect, Calibration not possible	Error ranges ⑦ ⑧ Check configuration	Error ranges ④ ⑤ ⑥ ("Loose contact")
13	114	<i><b>8.66</b></i> ↔ 10 ↔	Temperature fluctuates, Calibration not possible	Perform <b>AUTOCAL</b> and/or Error ranges ④ ⑤ ⑥ ("Loose contact")	Perform <b>AUTOCAL</b> and/or Error ranges ④ ⑤ ⑥ ("Loose contact")
	115		Ext. calibration temperature too large, Calibration not possible	Perform <b>AUTOCAL</b> with ext. calibration temperature ≤40 °C	Perform <b>AUTOCAL</b> with ext. calibration temperature ≤40 °C
	116		Ext. calibration temperature fluctuates, Calibration not possible	Perform <b>AUTOCAL</b> with stable ext. calibration temperature	Perform <b>AUTOCAL</b> with stable ext. calibration temperature

### 9.26 Error areas and causes

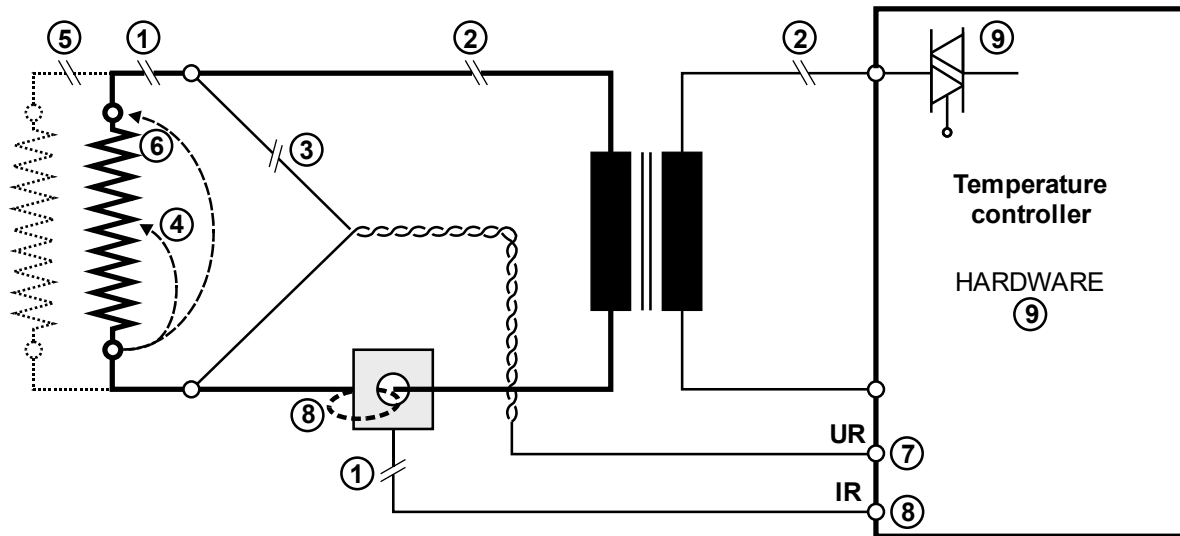

Explanations of the possible error causes can be taken from the following table.

Error range	Explanations	Possible causes
①	Interruption of the load circuit after the $U_R$ pickup point	- Wire break, heating element break - Contacting at the heating element defective
	Interruption of the signal from the transformer	- $I_R$ measurement line from the transformer interrupted
②	Interruption of the primary circuit	- Wire break, Triac defective in the controller - Primary winding of the impulse transformer interrupted - Kb conductor open
	Interruption of the secondary circuit in front of the $U_R$ pickup point	- Wire break - Secondary winding of the impulse transformer interrupted
③	$U_R$ signal missing	- Measurement cable interrupted
④	Partial short circuit (Delta R)	- Heating element is partially bridged through a conducting part (downholder, counter bar, etc.)
⑤	Interruption of the parallel circuit	- Wire break, heating element break - Contacting at the heating element defective
⑥	Complete short circuit	- Heating element incorrectly installed, insulation at the sealbar head missing or incorrectly installed - Conducting part bridges heating element completely
⑦	$U_R$ signal incorrect	- $U_2$ outside of the permitted range of 0.4...120 VAC
⑧	$I_R$ signal incorrect	- $I_2$ outside of the permitted range of 30...500 A
	Turns through current transformer incorrect	- Check number of turns (for current < 30 A, two or more turns are required)

Error range	Explanations	Possible causes
⑨	Internal device error/no line voltage	- Hardware error (replace controller) - Slide switch for alarm relay defective or not in correct position - Line voltage missing

## 9.27 Measures in the event of an error

### System incorrectly dimensioned:

The control can function properly only if all components are matched with one another. The ROPEX application report fulfils exactly this task and should therefore be fully implemented.

If the system is not designed according to the ROPEX application report, or if the martinal conditions change, this can lead to bad control or even malfunctions.

If the application changes, e.g. by increase in the cycle rate or change in the heating band dimensions, the application report must be updated accordingly. Inform us ([info@ropex.de](mailto:info@ropex.de)) and we will check what changes have to be made to your system so that the control can work again accurately.

### Check configuration:

In some cases the controller has to be operated outside of the technical specification. If this is the case, the relevant information is given in the ROPEX application report. The adjustments in the control loop, for example, by additional system components, or a modification to the controller, is described there. The necessary system components are also listed in the parts list.

Failure to comply with these instructions can lead to operational malfunctions.

### Loose contact:

The most common cause for errors is a loose contact. A loose contact can have several causes and occurs during operation. Before initiating a thorough search for a loose contact, you should first check all connections for a good and tight fit. Among others, weak spots can be plugs and very often clamping heads, screw connections and cable lugs.

Requirements for looking for loose contacts:

- We recommend having an electrician to troubleshoot the machine and an employee to operate the machine.
- A continuous START signal on the temperature controller must be possible, in order to be able to carry out continuous heating.
- It must be ensured that no dangerous movements can take place in the machine during the test, for example, by pressing the emergency stop.

Additional information:

- In case of parallel wiring of heating elements, both current circuits must be feed through the current transformer, so that a loose contact can be detected.
- The calibration process (AUTOCAL) must be carried out after changes to the system (cabling, connectors, tightening of screws, ...).

It is described below how you can locate a loose contact in your system:

1. Reset the alarm (e.g. press RESET).
2. Generate a continuous START signal on the controller at a temperature of 75 °C (corresponds to 2.5 V at the analogue output). Make sure that the heating does not lead to a dangerous situation in the machine.
3. The operator of the machine observes the displayed or measured temperature.



4. In the meantime, the electrician checks and moves the wires (high-current cables, measuring cables, ...). All plugs and contact blocks must also be checked by tapping them.
5. As soon as the displayed or measured temperature changes suddenly, the cause for the loose contact will be found.

If the controller goes into “fault” immediately, when a continuous START signal is generated, we recommend the following procedure:

1. The machine operator observes the displayed or measured temperature in the nonoperating state.
2. In the meantime, the electrician checks and moves the wires (high-current cables, measuring cables, ...). All plugs and contact blocks must also be checked by tapping them.

**Remarks:**

More time is required for this in the non-operating state, as measurements only take place every 1.2 seconds.

3. As soon as the displayed or measured temperature changes suddenly, the cause for the loose contact will be found.

If the alarm cannot be reset, the above-mentioned procedures cannot be used. In this case we recommend that you minimise your control system, e.g. to place a new sealing tool directly in front of the control cabinet and to connect it with new, short cables. Then carry out the AUTOCAL function and repeat the five steps listed above to locate the loose contact.





If the measures described has not led to success, please contact us directly ([info@ropex.de](mailto:info@ropex.de)) and send the following information to:

- Date and number of the application report and, if applicable, project name, as well as the used page and column.
- Actual implementation of the sealing application in the machine if this deviates from the application report.
- Relevant pages from its electrical circuit diagram, possibly information on plugs and connections.
- The error numbers that have occurred (can be read e.g. by using the ROPEX visualisation software).
- Description of the error and measures taken so far.
- Serial number and production date of the temperature controller.

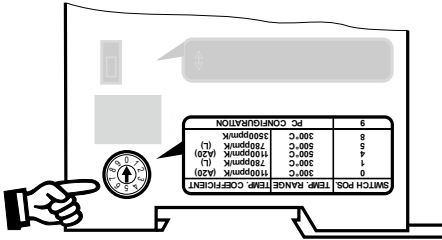
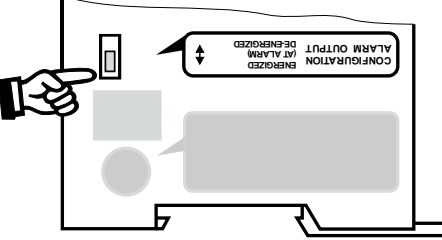
## 10 Factory settings

The RESISTRON<sup>®</sup> Temperature Controller RES-5008 is configured as follows from the factory:

<p><u>Rotary encoder switch</u> for Heating element alloy and Temperature range</p>	 <table border="1" data-bbox="667 1630 874 1720"> <thead> <tr> <th>SWITCH POS.</th> <th>TEMP. RANGE</th> <th>TEMP. COEFFICIENT</th> </tr> </thead> <tbody> <tr> <td>0</td> <td>300°C</td> <td>1100ppmk (A20)</td> </tr> <tr> <td>1</td> <td>500°C</td> <td>1750ppmk (L)</td> </tr> <tr> <td>4</td> <td>500°C</td> <td>1100ppmk (A20)</td> </tr> <tr> <td>5</td> <td>500°C</td> <td>1750ppmk (L)</td> </tr> <tr> <td>8</td> <td>300°C</td> <td>1100ppmk (A20)</td> </tr> </tbody> </table>	SWITCH POS.	TEMP. RANGE	TEMP. COEFFICIENT	0	300°C	1100ppmk (A20)	1	500°C	1750ppmk (L)	4	500°C	1100ppmk (A20)	5	500°C	1750ppmk (L)	8	300°C	1100ppmk (A20)	<p>Heating element alloy: Alloy A20 Temperature range: 300 °C</p> <p>Rotary encoder switch: Position “0”</p>
SWITCH POS.	TEMP. RANGE	TEMP. COEFFICIENT																		
0	300°C	1100ppmk (A20)																		
1	500°C	1750ppmk (L)																		
4	500°C	1100ppmk (A20)																		
5	500°C	1750ppmk (L)																		
8	300°C	1100ppmk (A20)																		
<p><u>Slide switch</u> for Alarm relay</p>	 <p>CONFIGURATION ENERGIZED ALARM OUTPUT DEENERGIZED</p>	<p>Alarm relay active in case of alarm</p>																		

Measurement impulse duration		Measurement impulse duration: 1.7 ms
Automatic Phase correction (AUTOCOMP)		AUTOCOMP: off
Temperature diagnosis		Temperature diagnosis: deactivated
Heat-up time monitoring		Heat-up time monitoring: deactivated

## 11 Maintenance

The controller does not require any special maintenance. Regular checking and retightening of the connection terminals is recommended. Dust deposits on the controller can be removed with dry compressed air when the power is off.

	<b>WARNING</b>
	Dust deposits and dirt from liquids result in a loss of function. Therefore, installation in a control cabinet or junction box starting from protection class IP_54 is recommended.

## 12 Disposal



This device falls under the EC Directive 2012/19/EU to reduce the increasing amount of electronic waste. The aim of the EC directive is to reduce waste from electrical and electronic equipment and to dispose of it in an environmentally friendly manner.



In order to ensure material recycling or proper disposal, take the device to the municipal collection points provided for this purpose. Observe the local regulations.

Careless and uncontrolled disposal can cause damage to the environment and human health. Help protect the environment and human health, and dispose of the product or recycle it responsibly.

	<b>NOTE</b>
	This device must not be disposed of in the residual waste bin!

### 13 Technical data

	NOTE
<p>Operation of the RESISTRON® Temperature Controller RES-5008 outside of these technical specifications can lead to loss of warranty and can cause defects.</p>	

<b>Design</b>	<p>Regulator: Housing for electrical cabinet mounting                  Can be snapped on to TS35 top hat rail (35 mm) in accordance with EN 60715                  Basic surface: 90x75 mm; depth: 135 mm (incl. connection terminals)</p> <p>Terminal: Housing for panel mounting                  Dimensions (W x H): 96 x 48 mm, depth: 55 mm (without plug)</p>
<b>Line voltage</b>	<p>Connected between neutral conductor and an outside conductor:                  110 VAC -15%...300 VAC +10%                  or                  Connected between two outside conductors:                  110 VAC -15%...480 VAC +10%</p> <p> <b>CAUTION</b>  <b>The voltage between outside conductor and earth must not exceed 300 VAC.</b></p>
<b>Power supply</b>	<p>Symmetrical TN or TTsystem                  Overvoltage category III</p> <p> <b>CAUTION</b>  <b>Operation in voltage-free system (e.g. IT system) only after checking with ROPEX.</b></p>
<b>Line frequency</b>	<p>47...63 Hz, automatic frequency adjustment in this range</p>
<b>Current consumption</b> (Primary current of the impulse transformer)	<p><math>I_{max} = 5 \text{ A}</math> (ED = 100%)  <math>I_{max} = 25 \text{ A}</math> (ED = 20%, cycle duration 1 min)                  A booster must be used for higher current power requirements (↪ Chapter 16)</p>
<b>24 VDC power supply</b> Terminals 5+7	<p>24 VDC, <math>I_{max} = 200 \text{ mA}</math> (control mode), 1 A (switch-on current)                  Tolerance: <math>\pm 10\%</math>                  SELV or PELV supplied from maximum 300VAC, Cat II</p>
<b>Measurement range</b>	<p>Secondary voltage <math>U_R</math>: 0.4 ...120 VAC (lower voltages with MOD 01, higher voltages with a ROPEX series resistor)                  Secondary current <math>I_R</math>: 30...500 A with current transformer PEX-W4/W5 (lower currents: Secondary cables lead through the current transformer several times, higher currents with a load resistor)                  The dimensioning is made in the ROPEX application report.</p>

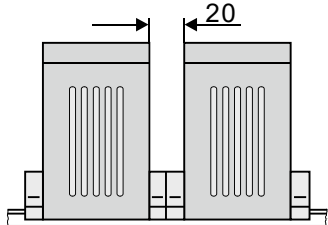
<b>Heating element type and temperature range</b>	<p>In addition to the setting through the rotary encoder switch, the setting for the temperature range and temperature coefficient can be made via the ROPEX visualisation software (↪ section 9.22 "USB-interface for visualisation software ROPEXvisual®" on page 47):</p> <p>Temperature range: 200 °C, 300 °C, 400 °C or 500 °C                  Temperature coefficient: 400...4000 ppm/K (variable setting range)</p> <p>Five ranges can be set using the rotary encoder switches:</p> <p>Temperature coefficient 1100 ppm/K, 0...300 °C (e.g. alloy A20)                  Temperature coefficient 780 ppm/K, 0...300 °C (e.g. alloy L)                  Temperature coefficient 1100 ppm/K, 0...500 °C (e.g. alloy A20)                  Temperature coefficient 780 ppm/K, 0...500 °C (e.g. alloy L)                  Temperature coefficient 3500 ppm/K, 0...300 °C</p> <p>Please take the necessary setting from the ROPEX application report</p>
<b>Analogue output</b> (Actual value) Terminals 17+7	0...10 VDC, $I_{\max} = 5 \text{ mA}$ Corresponding to 0...300 °C or 0...500 °C Accuracy: $\pm 1\%$ plus 50 mV
<b>Alarm relay</b> Terminals 12, 13, 14	$U_{\max} = 30 \text{ V (DC/AC)}$ , $I_{\max} = 1 \text{ A}$ , changeover contact, potential-free
<b>Power loss</b>	Max. 20 W
<b>MTTF as per ISO 13849-1</b>	1522 years (see EN ISO 13849-1, table C.3, Triacs)
<b>Ambient conditions</b>	Maximum altitude 2000 m Ambient temperature: +5...+45 °C Maximum relative humidity: 80% at temperatures up to +31 °C, decreasing linearly to 50% relative humidity at +45 °C.
<b>Degree of protection</b>	IP 20  <b>CAUTION</b> <b>When the terminals are open, the screw must be screwed in to ensure contact protection.</b>
<b>Mounting</b>	<p>If several devices are mounted on a top-hat rail, a minimum distance of 20 mm must be maintained. In order to ensure sufficient cooling, the ventilation slots in the housing must remain free.</p>  <p>When mounting on a horizontal top hat rail, the movable latch, which is necessary for fastening, must face downward.</p> <p>When mounting on a vertical top hat rail, end holders must be installed on both sides to fasten the regulator mechanically.</p>
<b>Weight</b>	Controller: approx. 0.7 kg (incl. plug-in connector parts) Terminal: approx. 0.15 kg
<b>Housing material</b>	Controller: plastic, polycarbonate, UL-94-V0 Terminal: black plastic, type Noryl SE1 GFN2

<p><b>Connecting cable</b> Type/cross-sections</p>	<p>Rigid or flexible; 0.2...2.5 mm<sup>2</sup> (AWG 24...12) Through pluggable terminals</p> <p>Pluggable terminals: Tightening torque: 0.5...0.6 Nm (Screwdriver: SZS 0.6x3.5 mm)</p> <p> <b>CAUTION</b> If ferrules are used, they must be crimped in accordance with DIN 46228 and IEC/EN 60947-1. Otherwise, correct electrical contact in the terminals is not guaranteed.</p>
--	--

## 14 Dimensions

RESISTRON<sup>®</sup> Temperature Controller RES-5008:

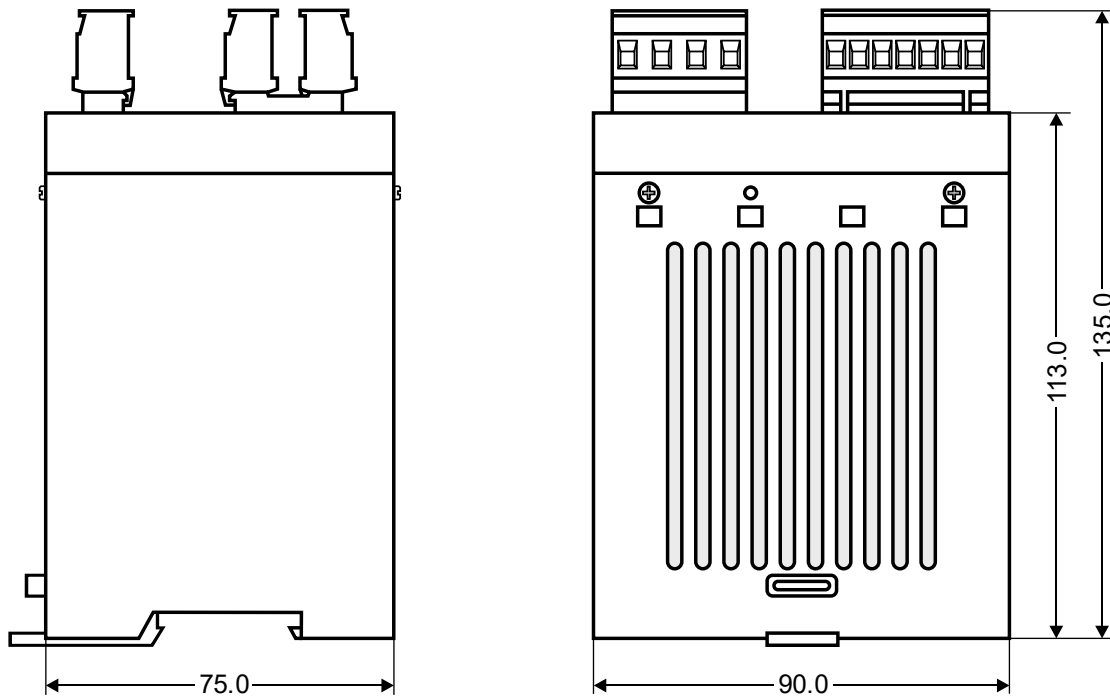

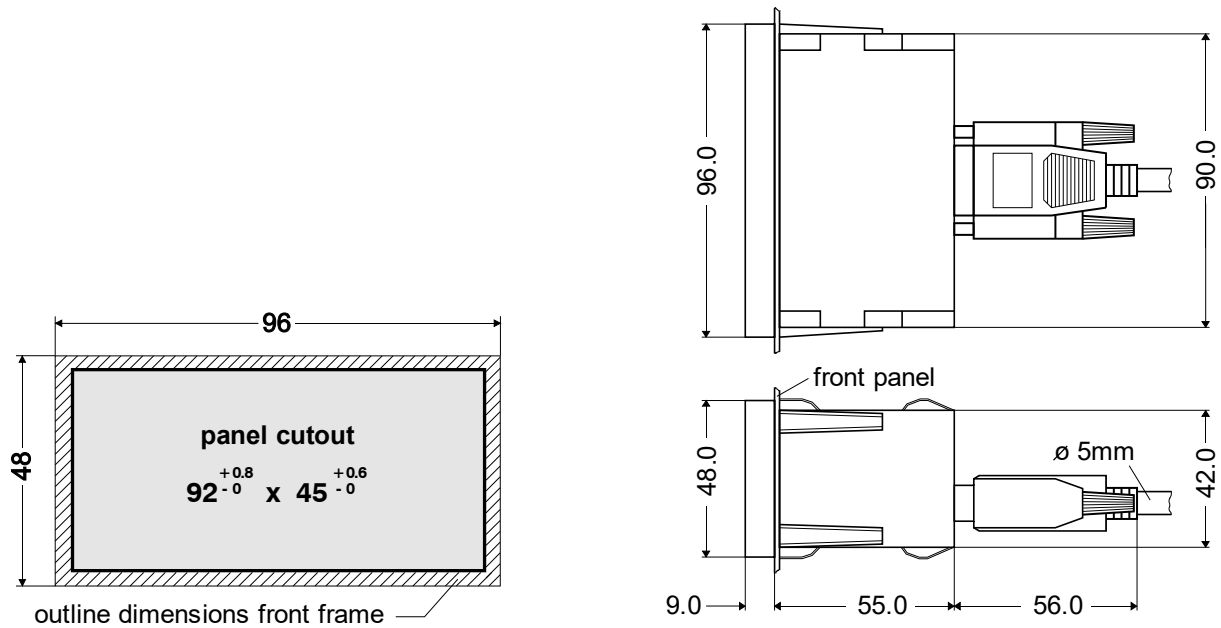
**Terminal T-408-1:**

## 15 Modifications (MODs)

The RESISTRON<sup>®</sup> Temperature Controller RES-5008 is suitable for very many sealing applications due to its universal design.

A device modification (MOD) is available for the RESISTRON<sup>®</sup> Temperature Controller RES-5008 to implement special applications.

The modifications must be ordered separately. The modification installed or configured in the controller is printed on the nameplate.

### MOD 01





Supplemental booster for small secondary voltages ( $U_R = 0.2 \dots 60 \text{ VAC}$ ). This modification is e.g. necessary for very short or for low-resistance heating elements.

### MOD 44

Measuring impulse extension is set to 2.3 ms in the factory.

## 16 How to order

 	<p><b>Controller RES-5008</b>                  Art. no. 7500800                  Scope of delivery: Regulator with plug-in terminal parts (without transformer)</p> <p><b>Terminal T-408-1</b>                  Art. no. 885441                  Scope of delivery: Terminal with fixing clips</p> <p><b>Sub-D-connection cable</b>                  2 m: Art. no. 884202                  5 m: Art. no. 884205                  10 m: Art. no. 884210</p> <p><b>Modification MOD . . (Optional, if necessary)</b>                  e.g.                  01: MOD 01, art. no. 800001 (additional booster for small voltage)</p> <p>The article numbers of the controller and of the desired modification (optional) must be specified when ordering,                  e.g. RES-5008 + MOD 01 (controller with additional gain for low voltage)                  Order of art. no. 7500800 + 800001</p>
	<p><b>Current transformer PEX-W5</b>                  Art. no. 885107</p>
	<p><b>HCB-1 high-current busbar</b>                  Art. no. 885110</p>
	<p><b>Monitoring current transformer MSW-2</b>                  Art. no. 885212</p>

	<p><b>Line filter LF- . . . . .</b></p> <p>→ <b>06480</b>: Continuous current 6 A, 480 VAC, art. no. 885500 (with UL certification)  <b>10520</b>: Continuous current 10 A, 520 VAC, art. no. 885504 (with UL and CSA certification)  <b>35480</b>: Continuous current 35 A, 480 VAC, art. no. 885506  <b>50520</b>: Continuous current 50 A, 520 VAC, art. no. 885509 (with UL and CSA certification)</p>
	<p><b>Impulsetransformer</b></p> <p>For design and order specifications, see ROPEX application report          Design in accordance with EN 61558 in IP00          Available with UL certifications and thermal switch, if necessary.          In addition, we can individually design and offer you an series transformer.</p>
	<p><b>Temperature display ATR- .</b></p> <p>→ <b>3</b>: 300 °C range, art. no. 882130  <b>5</b>: 500 °C range, art. no. 882150</p>
	<p><b>Booster B- . . . .</b></p> <p>→ <b>075415</b>: Impulse loaded 75 A, 415 VAC, art. no. 885302  <b>100400</b>: Impulse loaded 100 A, 400 VAC, art. no. 885304</p>
	<p><b>Lines</b></p> <p>For design and order specifications, see ROPEX application report</p>



## 17 Index

### Numbers

24 VDC power supply 59

### A

Actual value output 32  
Alarm output 48  
Alarm relay 23, 60  
Alloy 22, 26  
Ambient conditions 60  
Ambient temperature 60  
Application report 14, 17  
AUTOCAL 12, 26, 34  
AUTOCOMP 42  
Automatic phase correction 42  
Automatic zero calibration 34  
Automatic zeroing 12, 26  
AUTOTUNE 12  
AUX interface 48

### B

Booster 64  
Burning in the heating element 23, 26

### C

Celsius °C 39  
Changing the heating element 24, 26  
Circuit breaker 16  
Circuit diagram 19  
Commissioning 25  
Communication disorder 46  
Current transformer 10, 17, 63

### D

Degree of protection 60  
Design 59  
Device view 21  
Dimensions 61

### E

Error diagnosis 12  
Error ranges 55  
External switching amplifier 20, 64

### F

Fahrenheit °F 39  
Functional principle 12  
Fuse 16

### H

HEAT 35  
Heating element 9

Heating element type 60  
Heat-up time monitoring 45  
High altitude 60  
Humidity 60

### I

Impulse transformer 10, 16, 64  
Installation 13  
Installation rules 13

### L

LEDs 27  
Line filter 10, 16, 17, 64  
Line frequency 59  
Line voltage 59

### M

Mains connection 16  
Mains frequency 12  
Manual operation 32, 36  
Maximum measurement pause 46  
Measurement impulse duration 42  
Measurement pause 46  
Measurement range 59  
Modification (MOD) 62, 63  
Monitoring current transformer 63  
Mounting 60  
MSW-2 63

### O

Overcurrent device 16

### P

PEX-W5 63  
Phase correction 42  
Power loss 60  
Preheating 36  
PREHEAT-Signal 36

### R

Restart delay 45  
ROPEXvisual 47, 48

### S

Sealing temperature 35  
Setpoint specification 32  
Setup requirements 14  
Standby mode 47  
START-signal 35  
System diagnosis 47  
System monitoring 48

**T**

TCR 9  
TCR Calculator 40  
Temperature coefficient 9  
Temperature diagnosis 44, 45  
Temperature display 32, 64  
Temperature range 22, 60  
Temperature regulation 11  
Temperature setting 32  
Temperature unit 39  
Thermal impulse process 11  
Transformer 10, 16, 64

**U**

Undervoltage detection 46  
USB interface 47  
Use 11

**V**

Visualisation software 47

**W**

Wiring 14, 16